



(11) **EP 3 516 374 B1**

(12) **EUROPEAN PATENT SPECIFICATION**

(45) Date of publication and mention of the grant of the patent:
12.04.2023 Bulletin 2023/15

(51) International Patent Classification (IPC):
C09K 11/06 ^(2006.01) **G01N 21/64** ^(2006.01)
C12Q 1/04 ^(2006.01)

(21) Application number: **17787004.5**

(52) Cooperative Patent Classification (CPC):
G01N 21/6428; C09K 11/06; C12Q 1/04;
G01N 2021/6434

(22) Date of filing: **21.09.2017**

(86) International application number:
PCT/IB2017/055727

(87) International publication number:
WO 2018/055544 (29.03.2018 Gazette 2018/13)

(54) **METHOD, ARRANGEMENT, COMPUTER PROGRAM PRODUCT AND SENSOR FOIL FOR DETECTING MICROORGANISMS ON A SURFACE**

VERFAHREN, ANORDNUNG, COMPUTERPROGRAMM UND SENSORFOLIE ZUR DETEKTION VON MIKROORGANISMEN AUF EINER OBERFLÄCHE

PROCÉDÉ, AGENCEMENT, PRODUIT PROGRAMME D'ORDINATEUR ET CAPTEUR SOUS FORME DE FEUILLE DE MÉTAL POUR DÉTECTER DES MICRO-ORGANISMES SUR UNE SURFACE

(84) Designated Contracting States:
AL AT BE BG CH CY CZ DE DK EE ES FI FR GB GR HR HU IE IS IT LI LT LU LV MC MK MT NL NO PL PT RO RS SE SI SK SM TR

(74) Representative: **Reichert & Lindner Partnerschaft Patentanwälte Stromerstr. 2A 93049 Regensburg (DE)**

(30) Priority: **21.09.2016 EP 16189897**
10.11.2016 EP 16198160

(56) References cited:
WO-A1-2013/122852 US-A- 4 657 736
US-A1- 2012 145 882

(43) Date of publication of application:
31.07.2019 Bulletin 2019/31

(73) Proprietor: **PreSens Precision Sensing GmbH 93053 Regensburg (DE)**

(72) Inventors:
• **LIEBSCH, Gregor 93083 Obertraubling (DE)**
• **STANGELMAYER, Achim 86633 Neuburg an der Donau (DE)**
• **MEIER, Robert 93152 Nittendorf (DE)**

- **HENNING TSCHIRSCH ET AL: "An imaging method for oxygen distribution, respiration and photosynthesis at a microscopic level of resolution", NEW PHYTOLOGIST, vol. 196, no. 3, 1 November 2012 (2012-11-01), pages 926-936, XP055427579, ISSN: 0028-646X, DOI: 10.1111/j.1469-8137.2012.04295.x**
- **M KÜHL ET AL: "Functional and structural imaging of phototrophic microbial communities and symbioses", AQUATIC MICROBIAL ECOLOGY, vol. 53, 18 September 2008 (2008-09-18), pages 99-118, XP055196657, ISSN: 0948-3055, DOI: 10.3354/ame01224**

Note: Within nine months of the publication of the mention of the grant of the European patent in the European Patent Bulletin, any person may give notice to the European Patent Office of opposition to that patent, in accordance with the Implementing Regulations. Notice of opposition shall not be deemed to have been filed until the opposition fee has been paid. (Art. 99(1) European Patent Convention).

EP 3 516 374 B1

Description**BACKGROUND OF THE INVENTION**5 Field of the Invention

[0001] The invention relates to a method for detecting microorganisms on a surface. Additionally, the invention relates to an arrangement for detecting microorganisms on a surface.

[0002] Moreover, the invention relates to a computer program for detecting microorganisms on a surface.

10 **[0003]** Finally, the invention relates to a sensor foil used for the detection of microorganisms on a surface.

Description of the Background Art

15 **[0004]** Methods, arrangements and devices for detecting microorganisms on antimicrobial surfaces, other surfaces, which are contacted by a plurality of people or animals, or surfaces, which are presumed to be contaminated by microorganisms are well known in prior art. For example, these devices and methods are applied to such as, but not limited to, various surfaces in hospitals, such as operating units and emergency units, intensive care units, premature infants stations, normal hospital units, surfaces of touch displays in public transport systems, such as for example busses, trains and planes, department stores, public and private buildings, such as for example nurseries, preschools, schools, libraries, canteens, restaurant kitchens, cafeterias, butcheries, etc. Furthermore, these devices and methods are applied to human beings and animals, in particular, but not limited to, human beings or animals with immune deficiencies, for example premature babies, senior people, cancer patients taking immunosuppressants, etc.

20 **[0005]** One known method is the paddle test, also called "set-off test" or "wipe test" ("Abklatschtest" in German). One disadvantage of the paddle test is the long duration from sampling the microorganisms from a surface to be inspected to the receiving the results, since it takes up to two days from the sampling to the test results. Another disadvantage of the paddle test is that the sample is transferred from the sampling site to an incubator in a laboratory. The detection of the sample is therefore not carried out in situ (on-site), which in turn means that it may take too long for the results, before the results are available, whereas the problem of, for example, germination still exists on-site, i.e. at the site of the surface to be inspected and detected. Still a further disadvantage of the paddle test is that there is no evaluation of the actual distribution of the microorganisms in situ, but rather an evaluation after the microorganisms of the original sample have been further grown or multiplied for a certain time, and thus the subsequent detection is no longer performed based on the original sample. Hence, conventional detection methods and arrangements are based on proliferation (cell division) and measure turbidity resulting from increased cell material (e.g., Biomerieux, Vitek and AST cards). This can lead to distortion of results, in particular with regard to the actual quantities and the actual distribution of the microorganisms at the sampling site.

30 **[0006]** Another known method is the coloring of the microorganisms for detection, wherein a sample preparation as well as post-processing are required, such as, for example, cleaning the location of the sampling, which makes the method cumbersome and inefficient.

35 **[0007]** Henning TSCHIERSCHE et al., "An imaging method for oxygen distribution, respiration and photosynthesis at a microscopic level of resolution", *New Phytologist*, vol. 196, no. 3, November 2012, pages 926-936, XP055427579, ISSN 0028-646X, DOI 10.1111/j.1469-8137.2012.04295.x, discloses an arrangement for detecting microorganisms on a surface being examined. A sensor foil has an oxygen-permeable layer (polymer layer) doped with an oxygen indicator dye and an oxygen-impermeable at least partially transparent read-out carrier layer (polyester support) carrying the oxygen-permeable layer. The oxygen-permeable layer is not loaded with oxygen. Notably, the imaging technique relies on there being a restricted liquid layer between the sensor foil and the surface being examined.

40 **[0008]** M KUHL et al., "Functional and structural imaging of phototrophic microbial communities and symbioses", *Aquatic Microbial Ecology*, vol. 53, 18 September 2008, pages 99-118, XP055196657, ISSN 0948-3055, DOI 10.3354/ame01224, gives an overview of recent (at the time of the publication of this article) developments in O₂, variable fluorescence and HS (hyperspectral) imaging. In particular, various arrangements for detecting microorganisms on a surface being examined are described. These arrangements may comprise a sensor foil having an oxygen-permeable layer doped with an oxygen indicator dye. The sensor foil also comprises an oxygen-impermeable at least partially transparent read-out carrier layer carrying the oxygen-permeable layer. The sample, for example a biofilm or microbial mats, are examined inside a flowchamber containing a liquid medium. WO 2013/122852 A1 A discloses a biological sterilization indicator device. The device comprises a body, a plurality of test microorganisms, and an oxygen-modulated first fluorescent sensor. The body comprises a first layer attached to a second layer, forming at least one isolatable microchamber and at least one primary passageway that provides fluidic communication between ambience and the at least one microchamber. The plurality of test microorganisms and the oxygen-modulated first fluorescent sensor are disposed in the microchamber.

5 [0009] US 2012/145882 A1 discloses a sensor assembly, a method, and a measuring system for capturing the distribution of at least one variable of an object. The sensor assembly has at least one sensor element comprising at least one first sensor sub-element and at least one second sensor sub-element. The at least one first sensor sub-element is transparent for at least one wavelength region of light, the at least one second sensor sub-element is sensitive to at least one variable.

10 [0010] US 4 657 736 A discloses an O₂ sensor element which contains a fluorescent indicator substance. A polymerized silicone polymer is used as a carrier material in which the indicator substance is incorporated in solubilized form and in an at least approximately homogeneous distribution. Solubilization of the indicator substance may essentially be performed in analogy to Friedel-Crafts alkylation of aromatics, which will increase solubility of the indicator substance in the polymer carrier without affecting quenching behavior.

SUMMARY OF THE INVENTION

15 [0011] It is therefore an object of the invention to provide a method for detecting microorganisms on a surface which is easy to carry out and provides the information about the presence, absence or vitality of microorganisms in a short period of time.

[0012] The above object is achieved by a method for detecting microorganisms on a surface according to the features of claim 1.

20 [0013] It is also an object of the invention to provide an arrangement for detecting microorganisms on a surface which is easy to use, simple and compact in construction and provides the information about the presence, absence or vitality of microorganisms in a short period of time.

[0014] The above object is achieved by an arrangement for detecting microorganisms on a surface according to the features of claim 6.

25 [0015] A further object of the invention is to provide a computer program product disposed on a non-transitory computer readable medium for detecting microorganisms on a surface which is easy to use on stationary, mobile and/or integrated devices and provides an information about the presence, absence or vitality of microorganisms in a short period of time.

[0016] The above object is achieved by a computer program product for detecting microorganisms on a surface according to the features of claim 11.

30 [0017] Another object of the invention is to provide a sensor foil for detecting microorganisms on a surface which can be applied in situ to the surface to be tested, is easy to use and provides the information about the presence, absence or vitality of microorganisms in a short period of time.

[0018] The above object is achieved by a sensor foil for detecting microorganisms on a surface having the features of claim 13.

35 [0019] In an exemplary embodiment of the invention, a method for detecting microorganisms on a surface covered with microorganisms is provided. The method is as well applicable for tests showing the functionality of antibiotic surfaces. In the beginning, at least a portion of the surface to be examined is covered with a sensor foil. The sensor foil is attached to the surface to be examined in an airtight manner. In the context of the present invention, "air tight manner" means that the ingress of ambient air between the surface and a first free surface side of an oxygen-permeable layer of the sensor foil, which is in contact with the surface to be examined, is hindered and avoided. The oxygen-permeable layer
40 of the sensor foil is doped with an oxygen indicator dye and loaded with oxygen, for example loaded at an ambient air oxygen level. The oxygen-permeable layer of the sensor foil faces the at least one portion of the surface to be examined. Next a detection element is placed in relation to the sensor foil.

45 [0020] For carrying out the detection of the presence or absence of microorganisms on the surface an excitation light is directed through an oxygen-impermeable at least partially transparent read-out carrier layer of the sensor foil and to illuminate the oxygen-permeable layer of the sensor foil with a required wavelength or wavelength spectrum to excite the oxygen indicator dye and optionally at least one reference dye. It is noted herein that in the context of the present invention, the property "at least partially transparent" of the read-out carrier layer means that the read-out carrier layer is at least partially transparent with regard to said excitation light. For reasons of conciseness the term "at least partially" is usually omitted in the description. The excitation light excites the oxygen indicator dye in the oxygen-permeable layer.
50 An emission (light emission) of the oxygen indicator dye is transmitted through the oxygen-impermeable at least partially transparent read-out carrier layer of the sensor foil. The detection element samples over or after a period of time the emission of the oxygen indicator dye from the oxygen-permeable layer and emission indicative to the amount of oxygen consumed by microorganisms from the oxygen-permeable layer covering the at least one portion of the surface.

55 [0021] Such a method is easy to carry out and delivers fast and correct results in situ. In other words, the sensor foil is kept in ambient air of said at least one portion of the surface, so that the sensor foil is "loaded" with ambient air oxygen. The surface and the possible microorganisms on the surface of the sample (at least one portion of the surface) are covered in an airtight manner to be detected by means of the sensor foil, wherein re-oxygenation from ambient air is blocked and the possible microorganisms are covered or even sealed between one or more oxygen impermeable layers.

The measurement with respect to oxygen consumption of possible microorganisms can start immediately. While the microorganisms "breathe" the oxygen out of the sensor foil, the oxygen sensor foil shows oxygen decrease in response to microorganisms respiration.

5 **[0022]** The results can be immediately viewed via a display of an embedded device, for example a mobile device, laptop, tablet, smartphone, cellular phone or the like. In order to make the emission viewable, the detector element can be a detector chip and part of a detection device and the emission of the oxygen indicator dye is imaged with a suitable optic on the detector chip.

10 **[0023]** According to a further embodiment of the invention, the detection element is a detector chip. The detector chip is directly attached to the at least partially transparent read-out carrier layer for receiving the emission of the oxygen indicator dye. No optics is needed to image the emission of the oxygen indicator dye onto the detector chip. The emission of the oxygen indicator dye is projected onto the detector chip. The detector chip can be equipped with an OLED in order to excite the sensor foil at the measurement site (surface to be examined for microorganisms). Thus, no further excitation light sources are needed, for example ring light around a detection element (for example, camera objective). The sensor foil response can be read-out with the naked eye, so that a user can directly see the presence or absence of microorganisms on the surface to be examined. Additionally, the sensor foil response can be read-out through an electronic detection element.

15 **[0024]** Note that throughout the specification, the term "microorganisms" means any oxygen-breathing organism or anaerobic organism. The term "in situ" means the place of the environment, i.e. the surface, to be inspected by the method, arrangement, computer program product or sensor foil of the present invention.

20 **[0025]** In all embodiments described above and in the following, any oxygen dissolved in the oxygen-permeable layer (sensitive polymer layer) of the sensor foil represents an "oxygen reservoir" which is consumed, if there are any oxygen-breathing microorganisms on the surface to be inspected due to respiration of the microorganisms. The oxygen indicator dye in the oxygen-permeable layer then responds to the change of oxygen in the oxygen-permeable layer.

25 **[0026]** The method comprises a step of post-processing the detected emission, so that the absence and presence and/or the amount of the microorganisms and their distribution and/or even types are determined in situ with respect to the at least one portion of the surface. Based on the detected emission, for example a computer-implemented software is used to analyze detected emission. Thus, the software processes the detected results from the raw sensor foil response for displaying and post-processing the detected results in more detail. For example, an exact determination can be made of the amount of the microorganisms and their distribution present on the surface of the sample. Regions (regions of interest (ROIs)) colonized by microorganisms can be depicted down to micrometer resolution. All this is carried out again in situ and immediately along with the detection process. For example, the post-processing can provide a graphical representation or statistical evaluation of the concentration of the microorganisms by way of a 2-dimensional image of the distribution of microorganisms on at least a portion of the surface. A further possibility is a plot showing the development of the concentration of the microorganisms or a statistical evaluation of colonies or microorganisms per surface area over time.

30 **[0027]** The detector chip can be coupled to the evaluation unit, which can be a separate or an embedded device with regard to the detector chip, wireless or via a cable. Thus, the detector chip "reads" the sensor foil in situ and immediately along with the detection process, i.e. the emission transmitted through the oxygen-impermeable transparent read-out carrier layer to the detector chip. The data from the detector chip are processed in situ and immediately along with the detection process or subsequently to the recording process.

35 **[0028]** In an exemplary embodiment the method comprises a step of determining the minimum inhibitory concentration (MIC) based on the detected emission.

40 **[0029]** In an exemplary embodiment of the invention, an arrangement for detecting microorganisms consuming oxygen on a surface is provided. The arrangement comprises a sensor foil for covering at least a portion of the surface to be examined, preferably in an airtight manner. The sensor foil is essentially composed of two layers. A first layer is an oxygen-permeable layer doped with an oxygen indicator dye and loaded with oxygen from the environment. The oxygen-permeable layer "loads" oxygen from said environment. A second layer is an oxygen-impermeable transparent read-out carrier layer for carrying the oxygen-permeable layer.

45 **[0030]** The sensor foil has two opposite free surface sides. The first free surface side is a free surface side of the oxygen-permeable layer. The second free surface side is a free surface side of the oxygen-impermeable transparent read-out carrier layer.

50 **[0031]** The oxygen-permeable layer contacts the surface to be examined with the first free surface side of the oxygen-permeable layer. A read-out surface side of the oxygen-permeable layer, which side is opposite of the first free surface side in the oxygen-permeable layer, is covered with the oxygen-impermeable transparent read-out carrier layer. Hence, the first free surface side of the oxygen-permeable layer is an oxygen-permeable contact side towards the possible microorganisms, and the second free surface side of the oxygen-impermeable transparent read-out carrier layer is an oxygen-impermeable transparent read-out side towards the detection element.

55 **[0032]** Preferably, the arrangement comprises a detection element which is arranged in relation to the sensor foil for

receiving an emission of the excited oxygen indicator dye in the oxygen-permeable layer, wherein the emission is transmitted through the oxygen-impermeable transparent read-out layer. Preferably, an evaluation unit is in communicative connection with the detection element, for calculating at least a graphical or statistical representation of the received emission. Preferably, a display, which is connected to the evaluation unit, is adapted to display a graphical representation of a concentration of the microorganisms on the surface or a statistical representation of the amount of microorganisms per surface. The graphical representation is indicative to a presence of microorganisms on the at least one portion of the surface covered by the sensor foil.

[0033] According to an embodiment of the invention, a light source is provided and adapted to illuminate at least a portion of the sensor foil attached to at least a portion of the surface to excite the oxygen indicator dye in the oxygen-permeable layer. The emission transmitted through the oxygen-impermeable transparent read-out carrier layer is detected by the detection element (sensor chip) and processed by the evaluation unit. The arrangement as described above has the advantage that it is easy to use in situ, simple and compact in construction and delivers fast and correct results in situ.

[0034] In an exemplary embodiment, the detection element is a sensor chip to detect the emission of the oxygen indicator dye which is transmitted through the oxygen-impermeable transparent read-out carrier layer of the sensor foil. According to one possible embodiment of the invention, the sensor chip is directly attached to the transparent read-out carrier layer for receiving the emission of the oxygen indicator dye. The sensor chip can be in a communicative connection with the evaluation unit. Any communicative connection which is known in the art can be realized.

[0035] The sensor foil can be equipped with an OLED (organic light emitting diode) in order to excite the sensor foil at the measurement site (surface to be examined for microorganisms). Thus, no further excitation light sources are needed, for example ring light around a detection element (for example, camera objective). Omitting a detector chip, the sensor foil response can be read-out with the naked eye, so that a user can directly see the presence or absence of microorganisms on the surface to be examined. Additionally, the sensor foil response can be read-out through an electronic detection element. The OLED can be arranged in a line or in an array. The OLED is flexible and can be directly attached to the sensor foil which is attached to the surface to be examined for possible microorganisms. In this case, no optics, such as for example a camera, is required between the detector chip and the OLED or OLEDs equipped sensor foil on the one hand and the surface to be tested on the other hand. Additionally, the sensor foil response can be read-out through an electronic detection element.

[0036] In another embodiment, the detector chip is a CMOS (complementary metal-oxide-semiconductor). Thus, the detection by means of the detector chip is also easy to carry out, i.e. in situ (on-site) with respect to the location of the surface or sample to be inspected for possible microorganisms, i.e. without preparation or follow-up at the sample location. The handling of such a detection element or detector chip can be quickly learned by untrained personnel and provides objectified results. The arrangement according to the invention with the detection element or detection device is mobile-compatible, i.e. can be integrated or connected with a mobile or cellular phone or any other smart device.

According to another embodiment of the invention, the detection element is a detection device. The detection device is composed of at least one detector chip and an optic, which are held in position by a housing. The optic images the emission of the oxygen indicator dye, transmitted through the oxygen-impermeable transparent read-out layer of the sensor foil, onto the detector chip. The detector chip is in a communicative connection with the evaluation unit.

[0037] In an exemplary embodiment, the detection element or detection device is attached in a fixed or detachable manner to the second free surface side of the oxygen-impermeable transparent read-out layer of the sensor foil.

[0038] In an exemplary embodiment, the detection element or detection device encompasses at least one light source (light emitting element) adapted to direct an excitation light through the oxygen-impermeable transparent read-out carrier layer of the sensor foil to the oxygen-permeable layer of the sensor foil, so that the oxygen indicator dye in the oxygen-permeable layer is excited by the excitation light and emits the emission. This emission is then detected in any embodiment as described above by means of said detection element or device. The detection element or device is removably mounted to a second free surface side of the oxygen-impermeable transparent read-out layer of the sensor foil.

[0039] In an exemplary embodiment, the detection element or device has the at least one light source, the detector chip and any further optical elements integrated in the housing, which provides an arrangement that is even more easy to use, simple and compact in construction and delivers fast and correct results.

[0040] In an alternative embodiment, the sensor foil is read-out only via the camera and not by a detection element as described above. In case a camera is used, as described above, the camera "reads" the sensor foil in situ and immediately along with the detection process, i.e. the emission transmitted through the oxygen-impermeable transparent read-out carrier layer outside the environment and sensor foil to the detection element or device is imaged and digitally represented in situ and immediately along with the detection process. In an exemplary embodiment, the detection element or detector chip is connected with an evaluation unit for post-processing the detected emission, i.e. for evaluating the amount of oxygen detected by the detection element over a period of time. For example, types and/or amounts of the microorganisms are determined with respect to the surface and based on the detected emission, for example by a computer-implemented software in the evaluation unit. This is carried out immediately along with the detection and in

situ with respect to the surface to be inspected for possible microorganisms. Thus, regions colonized by microorganisms can be depicted and detected down to micrometer resolution.

5 [0041] In an exemplary embodiment, the oxygen-permeable layer of the sensor foil is doped with at least one reference dye for determining at least one parameter of the microorganisms, so that an emission of the at least one reference dye is transmitted through the oxygen-impermeable transparent read-out carrier layer and is detected by the detection element. Different dyes can be used for determining different properties the microorganisms to be detected, thereby characterizing the microorganisms.

10 [0042] According to the invention, a computer program product, disposed on a non-transitory computer readable medium, is used for detecting microorganisms on a surface. The computer program product comprises at last one computer executable process step operable to control a computer. Firstly, data are read from a detector chip which is placed in relation to a sensor foil. The sensor foil covers at least a portion of the surface to be examined in an airtight manner. An oxygen-permeable layer of the sensor foil is doped with an oxygen indicator dye, loaded with oxygen and faces the at least one portion of the surface. An oxygen-impermeable transparent read-out carrier layer of the sensor foil faces the detector chip. Preferably, with the computer program a calculation of the amount of the microorganisms and their distribution on at least one portion of the surface is carried out from the read data. Preferably, the computer program controls a display in order to show a graphical or statistical representation of a concentration of the microorganisms on the surface in or after defined time intervals.

15 [0043] In one embodiment, the computer program allows that at least one image window can be defined on the detector chip. Accordingly, the data are only read from the at least one image window in order to calculate the amount of the microorganisms as described above. According to the invention, an inventive sensor foil for detecting microorganisms on a surface has an oxygen-permeable layer carried by an oxygen-impermeable transparent read-out carrier layer adapted to carry the oxygen-permeable layer. The oxygen-permeable layer is doped with an oxygen indicator dye and loaded with oxygen. The oxygen-permeable layer is adapted to be attached to at least one portion of the surface in an airtight manner.

20 [0044] It is advantageous if the sensor foil is bendable and flexible. The sensor foil can be adapted and attached to any topology of the surface.

25 [0045] In an exemplary embodiment, the oxygen-permeable layer of the sensor foil comprises polyvinyl chloride. The oxygen-impermeable transparent read-out carrier layer of the sensor foil comprises polyester. The oxygen indicator dye is fluorescent, phosphorescent, luminescent, colormetric and/or has another optical property changing over time with respiration of oxygen by the microorganisms, for example, but not limited to, ruthenium metal-ligand complexes or metalloporphyrins. The oxygen-permeable layer of the sensor foil can have combinations of oxygen indicator dye and reference dyes which allows to carry out ratiometric measurements of microorganisms on various surfaces.

30 [0046] In further embodiments, the oxygen-permeable layer of the sensor foil is antimicrobial and/or antibiotic. For this, the oxygen-permeable layer of the sensor foil is treated and/or functionalized, for example coated or soaked with antibiotics in order to determine the degree of effectiveness of the antibiotics in a series of samples covered with the thus treated sensor foil, as will be described in more detail later. In order to distinguish between the functionality of the tested antibiotics (or other substance), a first free surface side of the oxygen-permeable layer of sensor foil carries a regular pattern of a plurality of fields. Each field, except one, contains a different type of an antibiotic. The field with no antibiotic is used as a reference field.

35 [0047] In general, the method, arrangement, computer program product and sensor foil of the present invention can be applied to an antimicrobial or antibiotic surface of an item, human being or animal, as described above in the background art section which surface is to be inspected with regard to potential microorganisms thereon. Thus, the method and the arrangement according to the present invention enable detection of any oxygen respiring or anaerobic microorganisms on any surface via monitoring their respiration with an oxygen sensor provided by the sensor foil of the method and arrangement as described above. In contrast to the prior art, no proliferation is necessary, since the O₂ consumption of any possibly existing microorganisms is measured, which is carried out very fast. However, a typical proliferation is present, which depends on the surrounding conditions the microorganisms are living in.

40 [0048] The surface with potential microorganisms can be a sample to be detected and can be examined in situ, within a short time period, typically 1 to 5 minutes, and without sample preparation. The size of the surface or surface region to be monitored and detected can be any size, for example from a few μm^2 up to cm^2 range. Even small surface regions with microorganisms ("hot spots") on relatively big surfaces can be identified and detected by the method, arrangement, computer program product and sensor foil of the present invention. The surface to be monitored and detected can also have any shape or topology. Further in general, the surface to be monitored is covered, in particular airtight sealed, with the oxygen sensor foil of the invention. The sensor foil can be a thin film. The shape of the sensor foil can be flexible and bendable, so that even uneven surfaces can be detected for microorganisms. As described above, an oxygen indicator dye doped and oxygen-permeable layer (oxygen sensitive layer) is fixed onto an oxygen-impermeable transparent read-out carrier layer (support). The oxygen content in the sensitive layer is equivalent to the oxygen partial pressure of the contacting phase or sample of the environment to be inspected for possible microorganisms. Thus,

oxygen is sensed by means of the sensor foil without oxygen consumption. Any detected oxygen change can be directly allocated to respiration of microorganisms.

[0049] The method, arrangement, computer program product and sensor foil of the present invention can also be used for testing whether an antimicrobially coated surface kills germs (as microorganisms) or an antimicrobially (pre)treated surface is germ-free or at least minimally contaminated by germs. For this, the surface can, for example, be antimicrobially coated. Furthermore, for this, the surface is either directly examined and measured with regard to the presence and/or distribution of germs (microorganisms) as described above, or the antimicrobial surface is intentionally contaminated with germs or other microorganisms, and the effectiveness of the killing of germs (microorganisms) or the reduction of germination by the antimicrobial surface is monitored.

[0050] In further embodiments of the inventive method and arrangement, the response of the microorganisms is "influenced". In one embodiment, a temperature of at least a part of the surface to be examined is changed, for example by a relatively moderate heating, for example by infrared (IR) or an internal tempering system in the sensor foil, in order to change an activity degree of the microorganisms, for example so that the microorganisms become more active. In another embodiment, at least a part of the surface to be examined is treated for example with UV radiation, so that the microorganisms are possibly killed; for example, the UV radiation is emitted from at least a part of the sensor foil. All changes of temperature can, for example, be carried out by at least a part of the sensor foil. In still another embodiment, at least one respiratory decoupler is placed on the oxygen-permeable layer of the sensor foil, so that the microorganisms are able to consume more oxygen (in comparison to that no respiratory decoupler is used) and a faster response time is achieved. These respiratory decouplers can be selected specifically for certain microorganisms, so that specific types of microorganisms can be targeted. In still another embodiment, specific antibiotics, as described above and below, for certain microorganisms are selected in such a way that specific types of microorganisms can be selectively killed or resistant microorganisms can be detected.

[0051] A further advantage, in addition to the other advantages mentioned, is that the sensor foil of the method and arrangement of the present invention does not require electricity. Further scope of applicability of the present invention will become apparent from the detailed description given hereinafter. However, it should be understood that the detailed description and specific examples, while indicating preferred embodiments of the invention, are given by way of illustration only, since various changes, combinations, and modifications within the scope of the invention will become apparent to those skilled in the art from this detailed description.

BRIEF DESCRIPTION OF THE DRAWINGS

[0052] The present invention will become more fully understood from the detailed description given herein below and the accompanying drawings which are given by way of illustration only, and thus, are not limiting to the present invention, and wherein:

- FIG. 1 is a flowchart of a method for detecting microorganisms according to an embodiment to the present invention;
- FIG. 2 is a schematic view of an arrangement for detecting microorganisms according to an embodiment to the present invention;
- FIG. 3 is a schematic view of an arrangement for detecting microorganisms according to a further embodiment to the present invention;
- FIG. 4 is a detailed view of the sensor foil according to an embodiment to the present invention;
- FIG. 5 is a schematic view of a detection element according to an embodiment of the present invention;
- FIG. 6 is a schematic view of the first free surface side of the oxygen-permeable layer to be in contact with the possible microorganisms on the surface to be detected, according to an embodiment of the present invention;
- FIG. 7 is a schematic view of an embodiment of an array with a series of samples to be detected for microorganisms;
- FIG. 8 is a schematic view of an embodiment of the display for showing a 2-dimensional distribution of microorganisms on the series of samples in FIG. 7;
- FIG. 9 is an exemplary time series of detection result images;
- FIG. 10 shows the first and the last detection result images of an exemplary time series with 200 samples and detection result images;
- FIG. 11 is a diagram with a graph showing the sensor foil response along the time axis for a first region of interest;
- FIG. 12 is a diagram with a graph showing the sensor foil response along the time axis for a second region of interest;
- FIG. 13 is a diagram with a graph showing the sensor foil response along the time axis for a third region of interest;
- FIG. 14 is a schematic view of another example of a response of a sensor foil according an embodiment of the invention for a sample, wherein two exemplary regions of interest are selected; and
- FIG. 15 is a diagram with two graphs regarding the two exemplary regions of interest in FIG. 14.

DETAILED DESCRIPTION OF THE DRAWINGS

[0053] Reference will now be made in detail to the subject matter disclosed, which is illustrated in the accompanying drawings. The scope of the invention is limited only by the claims; numerous alternatives, modifications and equivalents are encompassed. For the purpose of clarity, technical material that is known in the technical fields related to the

[0054] FIG. 1 is a flowchart of an embodiment of a method for detecting microorganisms 3 consuming oxygen 4. In step S1, at least a portion of the surface 2 to be detected or examined is covered with a sensor foil 20 in an airtight manner, wherein an oxygen-permeable layer 21 of the sensor foil 20 is doped with an oxygen indicator dye 26, loaded with oxygen 4 and faces the at least one portion of the environment 2.

[0055] In step S2, a detection element 30 is placed in relation to the sensor foil 20.

[0056] In step S3, an excitation light 32 is sent through an oxygen-impermeable transparent read-out carrier layer 24 of the sensor foil 20 to the oxygen-permeable layer 21 of the sensor foil 20, to the oxygen indicator dye 26 in the oxygen-permeable layer 21 which oxygen indicator dye 26 is then excited by the excitation light 32.

[0057] In step S4, an emission 27 of the oxygen indicator dye 26 transmitted through the oxygen-impermeable transparent read-out carrier layer 24 of the sensor foil 20 is detected by the detection element 30 over or after a period of time t , wherein the emission 27 of the oxygen indicator dye 26 from the oxygen-permeable layer 21 is indicative to the amount of oxygen 4 consumed by microorganisms 3 from the oxygen-permeable layer 21 covering the at least one portion of the surface 2.

[0058] In an optional step S5, the detected emission 27 is imaged or recorded, for example with a sensor chip 34 of the detection element 30 for detecting the emission 27.

[0059] In an optional query Q1, it is determined whether a next or another portion of the surface 2 should be examined; if so, step S1 to S4 and optionally S5 are repeated; if not, the method is terminated, or in an optional step S6, the detected emission 27 is post-processed, so that the amount and/or the distribution of the microorganisms 3 is/are determined in situ with respect to the at least one (current) portion on the surface 2 and based on the detected emission 27. The post-processing can be done, for example, by a computer-implemented software. Such a query Q1 can be useful in case more than one sample as portion of the surface 2 shall be examined for possible microorganisms 3. During step S4 or thereafter, for example the minimum inhibitory concentration (MIC) based on the detected emission 27 can be determined.

[0060] FIG. 2 shows a schematic view of an arrangement 1 for detecting microorganisms 3 consuming oxygen 4 according to an embodiment to the present invention.

[0061] The arrangement 1 provides a sensor foil 20 for covering at least a portion of the environment 2 to be detected. The sensor foil 20 is essentially composed of a first layer 11 and a second layer 12. The first layer 11 is an oxygen-permeable layer 21 doped with an oxygen indicator dye 26 and loaded with oxygen 4. The oxygen-permeable layer 21 "loads" oxygen (O_2) 4 from the environment and thus represents an oxygen reservoir inside the sensor foil 20 due to oxygen solubility in the polymer used. A second layer 12 is an oxygen-impermeable transparent read-out carrier layer 24 for carrying the oxygen-permeable layer 21.

[0062] The sensor foil 20 has a first free surface side 22 and a second free surface side 25. The first free surface side 22 is a free surface side of the oxygen-permeable layer 21 and is used to contact at least a portion of the surface 2. The second free surface side 25 is a free surface side of the oxygen-impermeable transparent read-out carrier layer 24.

[0063] A read-out surface side 23 of the oxygen-permeable layer 21 is covered with the oxygen-impermeable transparent read-out carrier layer 24. The read-out surface side 23 is opposite to the second free surface side 25 with regard to the oxygen-impermeable transparent read-out carrier layer 24.

[0064] In an embodiment of the invention, the arrangement 1 comprises a detection element 30 adapted to illuminate at least a portion of the sensor foil 20 attached to at least a portion of the surface 2 to excite the oxygen indicator dye 26 in the oxygen-permeable layer 21 and to detect an emission 27 transmitted through the oxygen-impermeable transparent read-out layer 24.

[0065] Hence, the first free surface side 22 of the oxygen-permeable layer 21 is an oxygen-permeable contact side towards the possible microorganisms 3, and the second free surface side 25 of the oxygen-impermeable transparent read-out carrier layer 24 is an oxygen-impermeable transparent read-out side towards the detection element 30.

[0066] In an embodiment of the invention, the arrangement 1 shown here, comprises a display 42 adapted to show a distribution of microorganisms 3, for example a 2-dimensional distribution, on the at least one portion of the sample 2. A statistical analysis of microorganisms per area on the surface is possible with the use of an evaluation unit 40 in communicative connection with the display 42. The detected emission 27 is indicative to a presence of microorganisms 3 on the at least one portion of the surface 2.

[0067] In the embodiment shown here, the detection element 30 is a detection device 38. The detection device 38 has at least one detector chip 34. The detector chip 34 and an optic 35 are held in position by a housing 33. The detector chip 34 is used to detect the emission 27 of the oxygen indicator dye 26 which is transmitted through the oxygen-impermeable transparent read-out carrier layer 24 of the sensor foil 20. The optic 35 can as well be held in position by

the housing 33. The optic 35 images the emission 27 of the oxygen indicator dye 26, which emission 27 is transmitted through the oxygen-impermeable transparent read-out layer 24 of the sensor foil 20, onto the detector chip 34. In the embodiment shown here, the detector chip 34 is in a communicative connection 39 with an evaluation unit 40. In the embodiment shown here, the evaluation unit 40 is a laptop with a display 42. It should be noted the laptop does not limit

the present invention, but any mobile device (evaluation unit 40 with display 42) can be used to practice the invention. **[0068]** In **FIG. 2** the housing 33 comprises at least one light source 31 (light emitting element) adapted to direct an excitation light 32 through the oxygen-impermeable transparent read-out carrier layer 24 of the sensor foil 20 to the oxygen-permeable layer 21 of the sensor foil 20. The oxygen indicator dye 26 in the oxygen-permeable layer 21 is excited by the excitation light 32 and emits the emission 27. However, the detection element 30 can encompass more than one light source 31 (not shown in drawings). In the embodiment shown here, the at least one light source 31 is a part of the housing 33 which is not limiting the invention, since another construction of a light source 31 can be used.

[0069] In an embodiment of the invention, the detection element 30 is connected with the evaluation unit 40 by a connection 35. A transmission circuitry 36 can be assigned to the detector chip 34. The evaluation unit 40 is used to evaluate the amount of oxygen 4 detected by the detection element 30 over or after a period of time t . By way of non-limiting example, the evaluation unit 40 illustrated in **FIG. 2** is configured with the above-mentioned display 42 adapted to show a distribution of microorganisms 3. It is obvious to a person skilled in the art that the display 42 can be provided as a separate device or integrated in the detection element 30 (see **FIG. 4**) or integrated in any other separate device, for example a smart device as mentioned above. The connection 35 between the detection element 30 and the evaluation unit 40 can comprise at least one cable or can be a wireless connection.

[0070] In an embodiment of the invention, the oxygen-permeable layer 21 of the sensor foil 20 for determining at least one parameter of the microorganisms 3 is doped with at least one reference dye 28 so that an emission 29 of the at least one reference dye 28 is transmitted through the oxygen-impermeable transparent read-out carrier layer 24 and is detected by the detection element 30.

[0071] **FIG. 3** shows a schematic view of an alternative embodiment of the arrangement 1 of the present invention. The detection element 30 is a sensor chip 34. The sensor chip 34 is directly attached to the second free surface side 25 of the transparent read-out carrier layer 24. The sensor chip 34 receives the emission 27 of the oxygen indicator dye 26. The sensor chip 34 is in a communicative connection 39 with the evaluation unit 40. The evaluation unit 40, shown here, is a mobile device with an integrated display 42. No optic 35, as necessary in the embodiment of **FIG. 2**, is needed. The detected emission 27 of the oxygen indicator dye 26 in the first layer 11 (oxygen-permeable layer 21) is projected onto the sensor chip 34. The composition of the sensor foil 20 is already described in **FIG. 2**.

[0072] **FIG. 4** shows a detailed view of the sensor foil 20 according to an embodiment to the present invention. According to an embodiment of the present invention, the oxygen-permeable layer 21 (first layer 11) of the sensor foil 20 comprises polyvinyl chloride.

[0073] In an embodiment of the invention, the oxygen-impermeable transparent read-out carrier layer 24 (second layer) of the sensor foil 20 comprises polyester.

[0074] In an embodiment of the invention, at least one oxygen indicator dye 26 or at least one oxygen indicator dye 26 plus at least one reference dye 28 are fluorescent, phosphorescent, luminescent, colorimetric and/or have another optical property changing over time t with respiration of oxygen 4 by the microorganisms 3.

[0075] **FIG. 5** shows a schematic view of a detection element 30 according to another embodiment to the present invention. In comparison to **FIG. 2**, in the detection element 30 according to the embodiment of **FIG. 5**, the evaluation unit 40 with the display 42 is communicatively attached to the detection element 30. The design of the detection element 30 is already described in **FIG. 2**. The evaluation unit 40, which can be, for example, a smart phone, is used as an embedded system for carrying out the evaluations of the data and information detected by the sensor foil 20. According to the evaluation, it is possible to show a 2-dimensional distribution of microorganisms 3 on the display 42 or carry out a statistical analysis of the microorganisms present on the at least one portion of the surface 2. The evaluation unit 40 can be an integrated part of the detection element 30.

[0076] Regardless of the embodiment, whether the evaluation unit 40 is an integrated part of the detection element 30 or not, the detection element 30 can be attached in a fixed or detachable manner to the second free surface side 25 of the oxygen-impermeable transparent read-out layer 24 of the sensor foil 20. This design provides a particularly compact detector element 30.

[0077] All further elements in **FIG. 5** have already been described with reference to **FIG. 2** in detail. The connection 39 between the detector element 30 and the evaluation unit 40 can be a hard wire connection or wireless connection.

[0078] For rather large surfaces 2 to be inspected for possible microorganisms 3, the sensor foil 20 can have respective similar extensions.

[0079] **FIG. 6** is a schematic view onto the first free surface side 22 of the oxygen-permeable layer 21 of the sensor foil 20 according to an embodiment of the present invention. The first free surface side 22 is in contact with the microorganisms 3 on the surface 2 to be detected. The first free surface side 22 of the oxygen-permeable layer 21 of sensor foil 20 carries a regular pattern of a plurality of fields $15_1, 15_2, \dots, 15_N$, wherein each field $15_1, 15_2, \dots, 15_N$, except at

least one reference field 14, carries a substance which is antimicrobial and/or antibiotic. The arrangement of the fields 15₁, 15₂, ..., 15_N and the at least one reference field 14 shows only one possible embodiment and does not limit the arrangement of the fields 15₁, 15₂, ..., 15_N and the reference field 14 on the first free surface side 22 of the sensor foil 20. For example, each field 15₁, 15₂, ..., 15_N can carry a different type of antibiotic in order to determine their effect on the microorganisms 3.

[0080] FIG. 7 is a schematic view of a further embodiment of an arrangement 1 according to the present invention. A plate 5 is provided with an array 6 of a series of samples 7_i, i = 1, ..., j, ..., k, ..., m. The individual samples 7_i represent individual environments 2 to be examined for possible microorganisms 3 by the method of the present invention. Each sample 7_i contains a probing solution with microorganisms 3, for example bacteria and/or fungi to be tested. For example, but not limited to, the samples 7_i contain immobilized antimicrobial substances of different concentration. A sensor foil 20 is configured so that it can cover a portion of the plate 5 with all the samples 7_i in an airtight manner and so that the microorganisms "breathe" directly into the oxygen-permeable layer 21 of the sensor foil 20.

[0081] A detection element 30, for example having a CMOS, is configured so that it illuminates at least a portion of the sensor foil 20 when attached to the plate 5 to excite the oxygen indicator dye 26 in the oxygen-permeable layer 21, to detect an emission 27 transmitted through the oxygen-impermeable transparent read-out layer 24 (see FIG. 2), and to read the sensor response of the sensor foil 20. Through this arrangement extremely small volumes ("Picoliter respiratory chambers") of samples 7_i can be produced and a time series of the response of the sensor foil 20 can be recorded, so that an oxygen consumption kinetics can be determined. For example, the minimum inhibitory concentration (MIC) based on the detected emission 27 and kinetics can be determined.

[0082] This arrangement is useful for sensitivity tests and detection of resistance mechanisms in clinically relevant bacteria and yeasts.

[0083] In further embodiments, the oxygen-permeable layer 21 of the sensor foil 20 is treated and/or functionalized.

[0084] In one embodiment, the oxygen-permeable layer 21 of the sensor foil 20 is coated or soaked with antibiotics in order to determine the degree of effectiveness of the antibiotics in a series of samples 7_i covered with the thus treated sensor foil 20.

[0085] The antibiotics should cause reduced respiration of the microorganisms (bacteria, fungi etc.). In case the microorganisms are sensitive to the antibiotics, the detected O₂ values remain high over time. In case the microorganisms are less sensitive to the antibiotics, the microorganisms alter their breathing and the O₂ values change by consumption. In case the microorganisms are resistant to the antibiotics, the microorganisms do not change their breathing and the O₂ values greatly decrease by O₂ consumption over time. Each sample 7_i is connected via a wire, cable or wireless connection 8_i with a circuitry 9 for sending the data to a remote or local evaluation unit (not shown).

[0086] FIG. 8 is a schematic view of an embodiment of a display 42 for showing a 2-dimensional distribution of microorganisms 3 on the series of samples 7_i in FIG. 5. Each sample 7_i is represented by a respective result image 43_i, i = 1, ..., j, ..., k, ..., m. Each result image 43_i shows, for example, a representative image taken by the detection element 30, which can be configured as a CCD-camera. When activating a single image icon 43_i, for example, further results details and/or a magnified image 43_i, are shown on display 42.

[0087] Function keys 44_n, n = 1, ..., o, enable the user to call various sub-routines in order to carry out different evaluations and/or graphical representations of the detected data. Additionally, the detection element 30 not shown can be controlled via specific function keys 44_n.

[0088] Thus, a time series of samples 7_i, i = 1, ..., j, ..., k, ..., m, as to detecting microorganisms 3 on these samples 7_i can be recorded with the detection element 30 and displayed via a respective time series of result images 43_i. For example, a surface partially colonized with microorganisms 3 is covered with a sensor foil 20 and read-out in fixed time intervals, for example 2 sec, as shown in FIG. 9. Hence, FIG. 9 is a time series of detection result images 43_i.

[0089] FIG. 10 shows the first last detection result image 43₁ and the last detection result image 43₂₀₀ of an exemplary time series with 200 samples 7_i, i = 1, ..., 200 (see FIG. 7), and therefrom resulting m = 200 detection result images 43_i, i = 1, ..., 200, as for example, shown in FIGS. 8 and 9.

[0090] In the exemplary series of samples 7_i, each sample 7_i, i = 1, ..., 200, is provided with the same amount of microorganisms 3, a maximum amount of antibiotics or a maximum strong antibiotics is added to the first sample 7₁, the last sample 7₂₀₀ contains no antibiotics, and with increasing index i = 2, ..., 199, an increasing amount of antibiotics or increasingly stronger antibiotics have been added to the respective samples 7_i. Then the method according to the invention is applied to each of the samples 7_i, for example as described with regard to FIG. 7, for detecting the remaining amounts of microorganisms 3 on the samples 7_i after they have been treated with the different amounts and/or strengths of antibiotics. At least one detection result image 43_i is taken of each sample 7_i. The content of a result image 43_i depends on the amount of antibiotics added to the respective sample 7_i, as will be described in the following.

[0091] In an embodiment of the invention, each O₂ value detected and indicating the presence or absence of microorganisms 3 by the method and/or arrangement 1 is assigned to a specific color 50, 51, ..., 55. Thus, the quantification, i.e. the amounts, of O₂ consumption across the respective sample 7_i can be visualized by means of the result images 43_i. The colors can be, but are not limited to, a range of greys or a range of any other colors of the known continuous

color spectrum. The sensor foil 20 should provide ratiometric properties accordingly. For mere explanation, in the example of FIG. 10, six distinctive separate colors 50, 51, ..., 55 have been chosen. However, in reality, the number of microorganisms 3 and hence the amount of O₂ usually changes across the sample to be detected in a continuous manner. Therefore, the colors selected for representation of the diverse O₂ amounts across the pixels of any single image 43_i can be taken from a continuous interval of the maximal O₂ value and the minimum O₂ value detected.

[0092] In the exemplary case of FIG. 10, light regions 45 in the last result image 43₂₀₀ represent surface portions of the respective last sample 7₂₀₀ where a maximum of microorganisms 3 are present, and hence, O₂ presence is low due to O₂ consumption of the microorganisms 3, represented, for example by the lightest color 55 in the chosen range of colors. Dark regions 46 in the last result image 43₂₀₀ represent other surface portions of the respective last sample 7₂₀₀ where the presence of microorganisms 3 is at its minimum, maybe even absent, and hence, O₂ presence is high, represented, for example by the darkest color 50 in the chosen range of colors. The series of result images 43_i thus visualize the degree of effectiveness of an antibiotic and the amounts of the antibiotic needed for reducing or even eliminating the microorganisms on the samples 7_i of an environment 2.

[0093] In the last result image 43₂₀₀, three regions of interest 56, 57, 58 are marked which are examined and described in more detail in FIGS. 11, 12, 13.

[0094] Reference sign 47 in the result images 43_i represents boundary lines of the surface 2 or boundaries of the sensor foil 20.

[0095] A person skilled in the art knows that any other range of colors can be chosen suitable for visualizing the amounts of O₂ and hence visualizing the amounts of microorganisms 3 on a sample 7_i, without departing from the scope of the invention. A person skilled in the art also knows that in the series of samples 7_i and result images 43_i, i = 1, ..., m, the total number m can be less or more than 200 and/or the total number m of result images 43_i can be equal or greater than the total number m of samples 7_i and/or the number of regions of interest 56, 57, 58 can be different from three without departing from the scope of the invention.

[0096] Description data 48, such as, but not limited to, the index i of a respective result image (slide) 43_i (for example 1 and 200), the total number of result images (slides) 43_i (for example 200), the date and time of the result images 43_i, the path where the file of the result image (slide) 43_i is saved, and the file name of the result image (slide) 43_i, can be added to each result image 43_i automatically by a respective software.

[0097] FIG. 11 is a diagram with a graph 62 showing the response of the sensor foil 20 as a function of time t along the X-axis X for the first region of interest 56 (ROI) in the last detection result image 43₂₀₀ of FIG. 10. Graph 62 shows a strong decrease of oxygen O₂ which means a high O₂ respiration rate which reaches a saturation after a certain period of time, which in turn means a high number of microorganisms in average present in the first region of interest 56. The scale of the Y-axis Y is in arbitrary units.

[0098] FIG. 12 is a diagram with a graph 63 showing the response of the sensor foil 20 of FIG. 10 as a function of time t along the X-axis X for the second region of interest 57 in the last detection result image 43₂₀₀ of FIG. 10. Graph 63 shows a mediate decrease of oxygen O₂ which means a mediate O₂ respiration rate. The scale of the Y-axis is in arbitrary units and the range of the Y-axis Y of FIG. 12 is lower than the range of the Y-axis Y in FIG. 11. This means in turn that a mediate number of microorganisms in average is present in the second region of interest 57.

[0099] FIG. 13 is a diagram with a graph 64 showing the response of the sensor foil 20 of FIG. 10 as a function of time t along the X-axis X for the third region of interest 58 in the last detection result image 43₂₀₀ of FIG. 10. Graph 64 shows a low decrease of oxygen O₂ which means a low O₂ respiration rate. The scale of the Y-axis is in arbitrary units and the range of the Y-axis Y of FIG. 13 is lower than the range of the Y-axis Y in FIG. 12. This means that a low number of microorganisms in average is present in the third region of interest 58.

[0100] For example, in FIGS. 11, 12 and 13 a ratiometric sensor foil 20 can be used which, for example ratiometric with regard to the colors red and green.

[0101] In another embodiment of the inventive arrangement and method, bacteria as microorganisms are detected on a surface via determining pH value changes. In general, most bacteria generate acids or protons during metabolism. Acids and protons influence the pH value of an aqueous phase. Bacterial growth is a spatially diverged phenomenon. Therefore 2-dimensional information has to be gained, which is achieved in the present invention through the result images 43 as response of the sensor foil 20. For example, pH changes caused by bacterial metabolism can be observed via optical pH sensor foils 20. For example, bacteria can be detected via determining pH value changes by using a planar optical sensor foil 20. A surface of a sample that is suspicious to contain (a relevant amount of) bacteria is covered with a planar optical pH sensor foil 20. The planar optical pH sensor foil 20 can consist of at least one fluorescent or colorimetric pH indicator that results in a pH dependent signal change. Further the planar optical pH sensor foil 20 can consist of a referencing element that enables referenced signal read out. Planar optical pH sensor foils 20 should comprise a certain amount of humidity for enabling a bacteria dependent pH-change. The signal change is read out in a spatially derived manner, e.g. with an array detector or a camera. pH changes can be monitored either as signal change after a certain period of time or in a time dependent experiment.

[0102] Spatially and time dependent signal changes in the response of the sensor foil 20 enable to locate regions in

a region of interest in a sample with pH changes by bacterial presence or growth. Signal thresholds of recorded pH changes can be used to determine positive and negative results. A color system can be used for the result images 43 resulting from the response of the sensor foil 20 as described above in order to visualize the results, i.e. the degree of presence or absence of bacteria in the sample. Metabolism activators can be used in the oxygen-permeable layer 21 of sensor foil 20 to enhance pH changes caused by bacterial growth and metabolism.

[0103] In another embodiment of the inventive arrangement and method, bacteria as microorganisms are detected on a surface via determining pCO₂ levels by using a pCO₂ sensitive sensor foil analogous to the respiration described above.

[0104] FIG. 14 is a schematic view of another example of a response of a sensor foil 20 according an embodiment of the invention for a sample, wherein two exemplary regions of interest 56, 57 are selected in a result image 43. FIG. 15 is a diagram with two graphs 61, 62 regarding the two exemplary regions 56, 57 of interest in FIG. 14. The first graph 61 shows the progress of the response of the exemplary sensor foil 20 as to the first region of interest 56, and thereby the progress of oxygen O₂ amounts in the first region of interest 56 in the sample as a function of time t along the X axis X. The first region of interest 56 is an area of the surface which is covered by the sensor foil where the population of microorganisms is high. Accordingly, the second graph 62 shows the progress of the response of the exemplary sensor foil 20 as to the second region of interest 57, and thereby the progress of oxygen O₂ amounts in the second region of interest 57 in the sample as a function of time t along the X axis X. In a time series, the result image 43 depicted in FIG. 14 is repeatedly recorded at certain time intervals and is represented in the two graphs 61, 62 in FIG. 15.

[0105] As described before, the sensor foil 20 is "charged" in ambient air before it is applied to the surface (oxygen partial pressure is identical to the environment inside the sensor and thus "high"). In regions where microorganisms 3 are not present, the oxygen partial pressure remains high, i.e. no breathing and no O₂ consumption occur, which can be represented, for example, by the color 50 blue or the darkest grey in the result image 43. In regions where microorganisms 3 are present, the oxygen partial pressure is reduced by breathing after a short time, i.e. respiration and consumption O₂ consumption occur, which can be represented, for example, by the color 55 yellow or white in the result image 43. If the above-described embodiment of an arrangement 1 with an OLED is used directly on the sensor foil 20, the user sees this colored result image 43 directly via the OLED. Therefore, in this embodiment, no optical read-out system, like for example a camera, is required to visualize microorganisms on the surface of the sample 7 to be tested. Evaluating the mean value over the entire sensor foil 20, i.e. essentially over the second region of interest 57, results in little change if only a few (microscopic small) microorganisms are present within this large region of interest 57. The partial strong change in small regions, like for example in the small region of interest 56, has little effect on the average value of a large region of interest, like for example of the large region of interest 57. This type of detection is typical for point measurements in which millimeter-sized points or spots are read "average" with an optical fiber.

[0106] If, however, the response of the sensor foil 20 is only evaluated around the spots emerging from oxygen consumption in small regions of interest like region 56, the oxygen partial pressure change at microscopically small regions can be evaluated with a significant change in the sensor response. For example, one uses the core property of a sensor, i.e. detecting at very high spatial resolution due to individual dyes, and of a camera, i.e. detecting two-dimensionally resolved sensor responses due to single pixels.

[0107] It is believed that the present disclosure and many of its attendant advantages will be understood by the foregoing description, and it will be apparent that various changes may be made in the form, construction and arrangement of the components without departing from the disclosed subject matter or without sacrificing all of its material advantages. The form described is merely explanatory, and it is the intention of the following claims to encompass and include such changes. Furthermore, it is to be understood that the invention is defined by the appended claims.

LIST OF REFERENCE NUMERALS

[0108]

1	arrangement
2	surface
3	microorganism
4	oxygen (O ₂)
5	plate
6	array
7 _i	sample, i = 1, ..., j, ..., k, ..., m
8 _i	wire, cable or wireless connection, i = 1, ..., j, ..., k, ..., m
9	circuitry
11	first layer
12	second layer

EP 3 516 374 B1

14	reference field
15 ₁ , 15 ₂ , ..., 15 _N	field
20	sensor foil
21	oxygen-permeable layer (sensitive layer, polymer layer)
5 22	first free surface side (oxygen-permeable contact side to microorganisms)
23	read-out surface side
24	oxygen-impermeable at least partially transparent read-out carrier layer (polyester support)
25	second free surface side (oxygen-impermeable and at least partially transparent read-out side)
26	oxygen indicator dye
10 27	emission of oxygen indicator dye
28	reference dye
29	emission of reference dye
30	detection element
31	light source (light emitting element)
15 32	excitation light
33	housing
34	detector chip, sensor chip
35	optic
36	transmission circuitry
20 38	detection device
39	connection
40	evaluation unit
42	display
43 _i	result image (slide), i = 1, ..., j, ..., k, ..., m
25 44 _n	function key, n = 1, ..., o
45	image region with microorganisms present
46	image region with microorganisms absent
47	boundary line
48	description data
30 50	color
51	color
52	color
53	color
54	color
35 55	color
56	first region of interest
57	second region of interest
58	third region of interest
60	graph
40 61	graph
62	graph
63	graph
64	graph
Q1	query of examining next portion of environment
45 S1	step of covering at least a portion of the environment to be detected with a sensor foil in an airtight manner
S2	step of placing a detection element in relation to the sensor foil
S3	step of sending an excitation light through an oxygen-impermeable at least partially transparent read-out carrier layer of the sensor foil to the oxygen-permeable layer of the sensor foil
50 S4	step of detecting an emission of the oxygen indicator dye transmitted through the oxygen-impermeable at least partially transparent read-out carrier layer of the sensor foil by the detection element over a period of time
S5	step of imaging the detected emission
S6	step of post-processing the detected emission
55 t	time
X	X-axis
Y	X-axis

Claims

1. A method for detecting microorganisms (3) on a surface (2) being examined, the method **characterized by:**

5 attaching (S1) a first free surface side (22) of an oxygen-permeable layer (21) of a sensor foil (20) to at least one portion of the surface (2) being examined with in an airtight sealed manner by the sensor foil (20) blocking re-oxygenation of the oxygen-permeable layer (21) of the sensor foil (20) so that the microorganisms (3) breathe directly into the oxygen-permeable layer (21) of the sensor foil (20), wherein the oxygen-permeable layer (21) of the sensor foil (20) is doped with an oxygen indicator dye (26), loaded with oxygen (4) and faces the at least one portion of the surface (2);

10 placing (S2) a detection element (30) in relation to the sensor foil (20)
exciting (S3) the oxygen indicator dye (26) in the oxygen-permeable layer (21) with an excitation light (32) through an oxygen-impermeable at least partially transparent read-out carrier layer (24) of the sensor foil (20), the oxygen-impermeable at least partially transparent read-out carrier layer (24) carrying the oxygen-permeable layer (21); and

15 detecting (S4) an emission (27) of the oxygen indicator dye (26) when the oxygen indicator dye (26) is in an excited state, the emission (27) being transmitted through the oxygen-impermeable at least partially transparent read-out carrier layer (24) of the sensor foil (20) by the detection element (30) over or after a period of time (t), wherein the received emission (27) of the oxygen indicator dye (26) from the oxygen-permeable layer (21) is indicative of a decrease of oxygen (4) in the oxygen-permeable layer (21) of the sensor foil (20) and thus of a presence and concentration of the microorganisms (3) on the at least one portion of the surface (2) being examined airtight sealed by the sensor foil (20).

25 2. The method as claimed in claim 1, wherein the detection element (30) is a detector chip (34) and the detector chip (34) is directly attached to the at least partially transparent read-out carrier layer (24) for receiving the emission (27) of the oxygen indicator dye (26), or the detector chip (34) is part of a detection device (38) and the emission (27) of the oxygen indicator dye (26) is imaged on the detector chip (34) for detecting the emission (27).

30 3. The method as claimed in any one of the preceding claims, comprising:
post-processing (S6) the detected emission (27), so that the presence of microorganisms (3) and their distribution are determined in situ with respect to the at least one portion of the surface (2); and
displaying a graphical representation or a statistical evaluation (43, 47, 48, 50 - 58, 60 - 64) of a concentration of the microorganisms (3) on the surface (2) based on the detected emission (27); wherein the graphical representation or the statistical evaluation (43, 47, 48, 50 - 58, 60 - 64) of the concentration of the microorganisms (3) is a 2-dimensional image of the distribution of microorganisms (3) on at least a portion of the surface (2), a plot, showing the development of the concentration of the microorganisms (3) over time, or a statistical interpretation on the detected microorganisms.

40 4. The method as claimed in any one of the preceding claims, wherein a response of the microorganisms (3) to the at least one oxygen indicator dye (26) or at least one oxygen indicator dye (26) plus at least one reference dye (28) in the oxygen-permeable layer (21) of the sensor foil (20) is influenced.

5. The method as claimed in claim 4, wherein

45 a temperature of at least a part of the surface (2) to be examined is changed, for example by a relatively moderate heating, for example by infrared or an internal tempering system in the sensor foil (20), in order to change an activity degree of the microorganisms (3),

for example, the changes of temperature are carried out by at least a part of the sensor foil (20); and/or at least a part of the surface (2) to be examined is treated with UV radiation, so that the microorganisms (3) are killed,

50 for example, the UV radiation is emitted from at least a part of the sensor foil (20); and/or at least one respiratory decoupler is placed on the oxygen-permeable layer (21) of the sensor foil (20), so that the microorganisms (3) consume more oxygen (4) and a faster response time is achieved,

55 for example, the at least one respiratory decoupler is selected specifically for certain microorganisms (3), so that specific types of microorganisms (3) are targeted; and /or specific antibiotics for certain microorganisms (3) are selected in such a way that specific types of microorganisms (3) are selectively killed or resistant microorganisms (3) are detected.

6. An arrangement (1) for detecting microorganisms (3) on a surface (2) being examined,

the arrangement (1) **characterized by**

a sensor foil (20) having an oxygen-permeable layer (21) doped with an oxygen indicator dye (26) and loaded with oxygen (4) and an oxygen-impermeable at least partially transparent read-out carrier layer (24) carrying the oxygen-permeable layer (21),

the sensor foil (20) having a first and a second opposite free surface sides (22, 25), wherein the first free surface side (22) of the sensor foil (20) is a free surface side of the oxygen-permeable layer (21), and the second free surface side (25) of the sensor foil (20) is a free surface side of the oxygen-impermeable at least partially transparent read-out carrier layer (24),

the first free surface side (22) of the oxygen-permeable layer (21) of the sensor foil (20) being attached to at least one portion of the surface (2) being examined, and

the at least one portion of the surface (2) being examined being airtight sealed by the sensor foil (20) blocking re-oxygenation of the oxygen-permeable layer (21) of the sensor foil (20) so that the microorganisms (3) breathe directly into the oxygen-permeable layer (21) of the sensor foil (20);

a detection element (30) arranged in relation to the sensor foil (20) for receiving an emission (27) of the oxygen indicator dye (26) when the oxygen indicator dye (26) is in an excited state, the emission (27) being transmitted through the oxygen-impermeable at least partially transparent read-out layer (24) of the sensor foil (20);

an evaluation unit (40) for calculating a graphical or statistical representation (43, 47, 48, 50 - 58, 60 - 64) of the received emission (27); and

a display (42) connected to the evaluation unit (40) and adapted to display the graphical or statistical representation (43, 47, 48, 50 - 58, 60 - 64) of the received emission (27), the graphical or statistical representation (43, 47, 48, 50 - 58, 60 - 64) being indicative of a decrease of oxygen (4) in the oxygen-permeable layer (21) of the sensor foil (20) and thus of a presence and concentration of the microorganisms (3) on the at least one portion of the surface (2) being examined airtight sealed by the sensor foil (20).

7. The arrangement as claimed in claim 6, wherein a light source (31), providing excitation light (32), is placed in relation to the sensor foil (20) so that excitation light (32) reaches the oxygen-permeable layer (21) which is doped with the oxygen indicator dye (26) and loaded with oxygen (4).

8. The arrangement as claimed in claims 6 to 7, wherein the detection element (30) is a sensor chip (34), and the sensor chip (34) is directly attached to the at least partially transparent read-out carrier layer (24) for receiving the emission (27) of the oxygen indicator dye (26), and the sensor chip (34) is in a communicative connection with the evaluation unit (40).

9. The arrangement as claimed in claims 6 to 7, wherein the detection element (30) is a detection device (38) having at least one detector chip (34) and an optic (35) held in position by a housing (33), wherein the optic (35) images the emission (27) of the oxygen indicator dye (26), transmitted through the oxygen-impermeable at least partially transparent read-out layer (24) of the sensor foil (20) and then onto the detector chip (34), and the detector chip (34) is in a communicative connection with the evaluation unit (40), wherein the detection device (38) encompasses at least one light source (31), adapted to direct the excitation light (32) through the oxygen-impermeable at least partially transparent read-out carrier layer (24) of the sensor foil (20) to the oxygen-permeable layer (21) of the sensor foil (20), so that the oxygen indicator dye (26) in the oxygen-permeable layer (21) is excited by the excitation light (32) and emits the emission (27).

10. The arrangement (1) as claimed in claim 9, wherein the detection device (30) is attached in a fixed or detachable manner to the second free surface side (25) of the oxygen-impermeable at least partially transparent read-out layer (24) of the sensor foil (20).

11. A computer program product disposed on a non-transitory computer readable medium for detecting microorganisms (3) on a surface (2) being examined by the arrangement (1) as claimed in any one of claims 6 to 10, the computer program product comprising computer executable process steps operable to control a computer to:

- read data from the at least one detector chip (34) which is placed in relation to the sensor foil (20) attached in an airtight sealed manner to at least a portion of the surface (2) to be examined and an oxygen-impermeable at least partially transparent read-out carrier layer (24) of the sensor foil (20) faces the detector chip (34);
- calculate from the read data an amount of the microorganisms (3) and their distribution on at least one portion of the surface (2); and

- control the display (42) to show the graphical or statistical representation (43, 47, 48, 50 - 58, 60 - 64) of a concentration of the microorganisms (3) on the surface (2), based on the detected emission (27), in or after defined time intervals.

5 12. The computer program product as defined in claim 11, wherein at least one image window is defined on the detector chip (34) so that data are only read from the at least one image window in order to calculate the amount of the microorganisms (3).

10 13. A sensor foil (20) for detecting microorganisms (3) on a surface (2) being examined, the sensor foil (20) comprising:

- an oxygen-permeable layer (21) which is doped with an oxygen indicator dye (26) and loaded with oxygen (4), wherein the oxygen-permeable layer (21) is adapted to be attached in an airtight sealed manner to at least one portion of the surface (2) blocking re-oxygenation of the oxygen-permeable layer (21); and
- an oxygen-impermeable at least partially transparent read-out carrier layer (24) adapted to carry the oxygen-permeable layer (21),

15
20 wherein the sensor foil (20) is configured so that the microorganisms (3) "breathe" directly into the oxygen-permeable layer (21) of the sensor foil (20) and so that detecting microorganisms (3) on the surface (2) is based on a decrease of oxygen (4) in the oxygen-permeable layer (21) of the sensor foil (20) when attached in an airtight sealed manner to the at least one portion of the surface (2).

14. The sensor foil (20) as claimed in claim 13, wherein the sensor foil (20) is bendable and flexible.

25 15. The sensor foil (20) as claimed in any one of the claims 13 to 14, wherein a first free surface side (22) of the oxygen-permeable layer (21) of sensor foil (20) carries a regular pattern of a plurality of fields, wherein each field, except one, contains a different type of an antibiotic.

30 Patentansprüche

1. Verfahren zur Detektion von Mikroorganismen (3) auf einer zu untersuchenden Oberfläche (2), wobei das Verfahren **gekennzeichnet ist durch:**

35 Anbringen (S1) einer ersten freien Oberflächenseite (22) einer sauerstoffpermeablen Schicht (21) einer Sensorfolie (20) an mindestens einem Abschnitt der zu untersuchenden Oberfläche (2), wobei **durch** die Sensorfolie in einer luftdicht abgeschlossenen Weise eine Reoxygenierung der sauerstoffpermeablen Schicht (21) der Sensorfolie (20) blockiert wird, so dass die Mikroorganismen (3) direkt in die sauerstoffpermeable Schicht (21) der Sensorfolie (20) atmen, wobei die sauerstoffpermeable Schicht (21) der Sensorfolie (20) mit einem Sauerstoffindikatorfarbstoff (26) dotiert ist, mit Sauerstoff (4) beladen ist und dem mindestens einen Abschnitt der Oberfläche (2) zugewandt ist;

40 Anordnen (S2) eines Detektionselements (30) in Bezug auf die Sensorfolie (20);
Anregen (S3) des Sauerstoffindikatorfarbstoffs (26) in der sauerstoffpermeablen Schicht (21) mit einem Anregungslicht (32) **durch** eine sauerstoffimpermeable, zumindest teilweise transparente Auslese-Trägerschicht (24) der Sensorfolie (20), wobei die sauerstoffimpermeable, zumindest teilweise transparente Auslese-Trägerschicht (24) die sauerstoffpermeable Schicht (21) trägt; und

45 Erfassen (S4) einer Emission (27) des Sauerstoffindikatorfarbstoffs (26), wenn sich der Sauerstoffindikatorfarbstoff (26) in einem angeregten Zustand befindet, wobei die Emission (27) **durch** die sauerstoffimpermeable, zumindest teilweise transparente Auslese-Trägerschicht (24) der Sensorfolie (20) **durch** das Detektionselement (30) über oder nach einer Zeitspanne (t) transmittiert wird, wobei die empfangene Emission (27) des Sauerstoffindikatorfarbstoffs (26) aus der sauerstoffpermeablen Schicht (21) eine Abnahme von Sauerstoff (4) in der sauerstoffpermeablen Schicht (21) der Sensorfolie (20) und somit ein Vorhandensein und eine Konzentration der Mikroorganismen (3) auf dem mindestens einen **durch** die Sensorfolie (20) luftdicht abgeschlossenen Abschnitt der untersuchten Oberfläche (2) anzeigt.

50
55 2. Verfahren nach Anspruch 1, wobei das Detektionselement (30) ein Detektorchip (34) ist und der Detektorchip (34) direkt auf der zumindest teilweise transparenten Auslese-Trägerschicht (24) zum Empfangen der Emission (27) des Sauerstoffindikatorfarbstoffs (26) angebracht ist, oder der Detektorchip (34) Teil einer Detektionsvorrichtung (38) ist und die Emission (27) des Sauerstoffindikatorfarbstoffs (26) auf den Detektorchip (34) zur Detektion der Emission

(27) abgebildet wird.

3. Verfahren nach einem der vorhergehenden Ansprüche, umfassend:

5 Nachverarbeitung (S6) der erfassten Emission (27), so dass das Vorhandensein von Mikroorganismen (3) und deren Verteilung in situ in Bezug auf den mindestens einen Abschnitt der Oberfläche (2) bestimmt wird; und Anzeigen einer graphischen Darstellung oder einer statistischen Auswertung (43_i, 47, 48, 50-58, 60-64) einer Konzentration der Mikroorganismen (3) auf der Oberfläche (2) auf der Grundlage der erfassten Emission (27);
 10 wobei die graphische Darstellung oder die statistische Auswertung (43_i, 47, 48, 50-58, 60-64) der Konzentration der Mikroorganismen (3) ein zweidimensionales Bild der Verteilung der Mikroorganismen (3) auf mindestens einem Abschnitt der Oberfläche (2), ein Diagramm, das die Entwicklung der Konzentration der Mikroorganismen (3) über die Zeit zeigt, oder eine statistische Auswertung der detektierten Mikroorganismen ist.

15 4. Verfahren nach einem der vorhergehenden Ansprüche, wobei eine Reaktion der Mikroorganismen (3) auf den mindestens einen Sauerstoffindikatorfarbstoff (26) oder mindestens einen Sauerstoffindikatorfarbstoff (26) plus mindestens einen Referenzfarbstoff (28) in der sauerstoffpermeablen Schicht (21) der Sensorfolie (20) beeinflusst wird.

20 5. Verfahren nach Anspruch 4, wobei

eine Temperatur mindestens eines Teils der zu untersuchenden Oberfläche (2) verändert wird, beispielsweise durch eine relativ moderate Erwärmung, beispielsweise durch Infrarot oder ein internes Temperiersystem in der Sensorfolie (20), um einen Aktivitätsgrad der Mikroorganismen (3) zu verändern,
 25 die Temperaturänderungen beispielsweise durch mindestens einen Teil der Sensorfolie (20) erfolgen; und/oder mindestens ein Teil der zu untersuchenden Oberfläche (2) mit UV-Strahlung behandelt wird, so dass die Mikroorganismen (3) abgetötet werden,
 die UV-Strahlung beispielsweise von mindestens einem Teil der Sensorfolie (20) emittiert wird; und/oder
 30 mindestens ein Atmungskettenentkoppler auf der sauerstoffpermeablen Schicht (21) der Sensorfolie (20) aufgebracht ist, so dass die Mikroorganismen (3) mehr Sauerstoff (4) verbrauchen und eine schnellere Reaktionszeit erreicht wird,
 der mindestens eine Atmungskettenentkoppler beispielsweise spezifisch für bestimmte Mikroorganismen (3) ausgewählt wird, so dass bestimmte Arten von Mikroorganismen (3) angezielt werden; und/oder
 35 spezifische Antibiotika für bestimmte Mikroorganismen (3) in einer solchen Weise ausgewählt werden, dass bestimmte Arten von Mikroorganismen (3) selektiv abgetötet werden oder resistente Mikroorganismen (3) detektiert werden.

6. Anordnung (1) zur Detektion von Mikroorganismen (3) auf einer zu untersuchenden Oberfläche (2),

wobei die Anordnung (1) **gekennzeichnet ist durch**
 40 eine Sensorfolie (20), die eine sauerstoffpermeable Schicht (21), welche mit einem Sauerstoffindikatorfarbstoff (26) dotiert und mit Sauerstoff (4) beladen ist, und eine sauerstoffimpermeable, zumindest teilweise transparente Auslese-Trägerschicht (24) aufweist, welche die sauerstoffpermeable Schicht (21) trägt,

wobei die Sensorfolie (20) eine erste und eine zweite gegenüberliegende freie Oberflächenseite (22, 25) aufweist, wobei die erste freie Oberflächenseite (22) der Sensorfolie (20) eine freie Oberflächenseite der sauerstoffpermeablen Schicht (21) ist, und die zweite freie Oberflächenseite (25) der Sensorfolie (20) eine freie Oberflächenseite der sauerstoffimpermeablen, zumindest teilweise transparenten Auslese-Trägerschicht (24) ist,

wobei die erste freie Oberflächenseite (22) der sauerstoffpermeablen Schicht (21) der Sensorfolie (20) an
 50 mindestens einen Abschnitt der zu untersuchenden Oberfläche (2) angebracht ist, und wobei der mindestens eine Abschnitt der zu untersuchenden Oberfläche (2) durch die Sensorfolie (20) luftdicht abgeschlossen wird, wodurch eine Reoxygenierung der sauerstoffpermeablen Schicht (21) der Sensorfolie (20) blockiert wird, so dass die Mikroorganismen (3) direkt in die sauerstoffpermeable Schicht (21) der Sensorfolie (20) atmen;

55 ein Detektionselement (30), das in Bezug auf die Sensorfolie (20) angeordnet ist, um eine Emission (27) des Sauerstoffindikatorfarbstoffs (26) zu empfangen, wenn sich der Sauerstoffindikatorfarbstoff (26) in einem angeregten Zustand befindet, wobei die Emission (27) durch die sauerstoffimpermeable, zumindest teilweise transparente Ausleseschicht (24) der Sensorfolie (20) transmittiert wird;

EP 3 516 374 B1

eine Auswerteeinheit (40) zur Berechnung einer graphischen oder statistischen Darstellung (43, 47, 48, 50-58, 60-64) der empfangenen Emission (27); und
eine Anzeige (42), die mit der Auswerteeinheit (40) verbunden und geeignet ist, die grafische oder statistische Darstellung (43, 47, 48, 50-58, 60-64) der empfangenen Emission (27) anzuzeigen, wobei die graphische oder statistische Darstellung (43, 47, 48, 50-58, 60-64) eine Abnahme von Sauerstoff (4) in der sauerstoffpermeablen Schicht (21) der Sensorfolie (20) und somit ein Vorhandensein und eine Konzentration der Mikroorganismen (3) auf dem mindestens einen durch die Sensorfolie (20) luftdicht abgeschlossenen Abschnitt der untersuchten Oberfläche (2) anzeigt.

- 5
- 10
- 15
- 20
- 25
- 30
- 35
- 40
- 45
- 50
- 55
7. Anordnung nach Anspruch 6, wobei eine Lichtquelle (31), die Anregungslicht (32) liefert, in Bezug auf die Sensorfolie (20) so angeordnet ist, dass das Anregungslicht (32) die sauerstoffpermeable Schicht (21) erreicht, die mit dem Sauerstoffindikatorfarbstoff (26) dotiert und mit Sauerstoff (4) beladen ist.
 8. Anordnung nach einem der Ansprüche 6 bis 7, wobei das Detektionselement (30) ein Sensorchip (34) ist und der Sensorchip (34) direkt auf der zumindest teilweise transparenten Auslese-Trägerschicht (24) zum Empfangen der Emission (27) des Sauerstoffindikatorfarbstoffs (26) angebracht ist und der Sensorchip (34) in einer kommunikativen Verbindung mit der Auswerteeinheit (40) steht.
 9. Anordnung nach einem der Ansprüche 6 bis 7, wobei das Detektionselement (30) eine Detektionsvorrichtung (38) mit mindestens einem Detektorchip (34) und einer von einem Gehäuse (33) in Position gehaltenen Optik (35) ist, wobei die Optik (35) die Emission (27) des Sauerstoffindikatorfarbstoffs (26) abbildet, die durch die sauerstoffimpermeable, zumindest teilweise transparente Ausleseschicht (24) der Sensorfolie (20) transmittiert und dann auf den Detektorchip (34) übertragen wird, und der Detektorchip (34) in einer kommunikativen Verbindung mit der Auswerteeinheit (40) steht, wobei die Detektionsvorrichtung (38) mindestens eine Lichtquelle (31) umfasst, die geeignet ist, das Anregungslicht (32) durch die sauerstoffimpermeable, zumindest teilweise transparente Auslese-Trägerschicht (24) der Sensorfolie (20) auf die sauerstoffpermeable Schicht (21) der Sensorfolie (20) zu richten, so dass der Sauerstoffindikatorfarbstoff (26) in der sauerstoffpermeablen Schicht (21) durch das Anregungslicht (32) angeregt wird und die Emission (27) emittiert.
 10. Anordnung (1) nach Anspruch 9, wobei die Detektionsvorrichtung (30) in einer fest angebrachten oder lösbaren Weise an der zweiten freien Oberflächenseite (25) der sauerstoffimpermeablen, zumindest teilweise transparenten Auslese-Trägerschicht (24) der Sensorfolie (20) befestigt ist.
 11. Computerprogrammprodukt, das auf einem nichttransitorischen computerlesbaren Medium abgelegt ist, zur Detektion von Mikroorganismen (3) auf einer zu untersuchenden Oberfläche (2) durch die Anordnung (1) nach einem der Ansprüche 6 bis 10, wobei das Computerprogrammprodukt computerausführbare Prozessschritte umfasst, die dazu dienen, einen Computer zu steuern, um:
 - Daten aus dem mindestens einen Detektorchip (34) auszulesen, der in Bezug auf die Sensorfolie (20) angeordnet ist, die in einer luftdicht abschließenden Weise an mindestens einem Abschnitt der zu untersuchenden Oberfläche (2) angebracht ist, wobei dem Detektorchip (34) eine sauerstoffimpermeable, zumindest teilweise transparente Auslese-Trägerschicht (24) der Sensorfolie (20) zugewandt ist;
 - aus den ausgelesenen Daten eine Menge der Mikroorganismen (3) und deren Verteilung auf mindestens einem Abschnitt der Oberfläche (2) zu berechnen; und
 - die Anzeige (42) zu steuern, um auf der Grundlage der erfassten Emission (27) die graphische oder statistische Darstellung (43, 47, 48, 50-58, 60-64) einer Konzentration der Mikroorganismen (3) auf der Oberfläche (2) in oder nach definierten Zeitintervallen anzuzeigen.
 12. Computerprogrammprodukt nach Anspruch 11, wobei mindestens ein Bildfenster auf dem Detektorchip (34) definiert wird, so dass Daten nur aus dem mindestens einen Bildfenster ausgelesen werden, um die Menge der Mikroorganismen (3) zu berechnen.
 13. Sensorfolie (20) zur Detektion von Mikroorganismen (3) auf einer zu untersuchenden Oberfläche (2), wobei die Sensorfolie (20) umfasst:
 - eine sauerstoffpermeable Schicht (21), die mit einem Sauerstoffindikatorfarbstoff (26) dotiert und mit Sauerstoff (4) beladen ist, wobei die sauerstoffpermeable Schicht (21) geeignet ist, in einer luftdicht abgeschlossenen Weise an mindestens einem Abschnitt der Oberfläche (2) angebracht zu werden, wodurch eine Reoxygenierung

EP 3 516 374 B1

der sauerstoffpermeablen Schicht (21) blockiert wird; und

- eine sauerstoffimpermeable, zumindest teilweise transparente Auslese-Trägerschicht (24), die geeignet ist, die sauerstoffpermeable Schicht (21) zu tragen,

5 wobei die Sensorfolie (20) so konfiguriert ist, dass die Mikroorganismen (3) direkt in die sauerstoffpermeable Schicht (21) der Sensorfolie (20) "atmen" und so dass die Detektion von Mikroorganismen (3) auf der Oberfläche (2) auf einer Abnahme von Sauerstoff (4) in der sauerstoffpermeablen Schicht (21) der Sensorfolie (20) basiert, wenn diese in einer luftdicht abgeschlossenen Weise an dem mindestens einen Abschnitt der Oberfläche (2) angebracht ist.

10 **14.** Sensorfolie (20) nach Anspruch 13, wobei die Sensorfolie (20) biegsam und flexibel ist.

15. Sensorfolie (20) nach einem der Ansprüche 13 bis 14, wobei eine erste freie Oberflächenseite (22) der sauerstoffpermeablen Schicht (21) der Sensorfolie (20) ein regelmäßiges Muster aus einer Vielzahl von Feldern trägt, wobei jedes Feld, mit Ausnahme von einem, eine andere Art von Antibiotikum enthält.

15

Revendications

20 **1.** Procédé de détection de micro-organismes (3) sur une surface (2) sous examen, le procédé étant **caractérisé par** :

20

l'attache (S1) d'un premier côté de surface libre (22) d'une couche perméable à l'oxygène (21) d'une feuille de capteur (20) à au moins une portion de la surface (2) sous examen de manière hermétiquement fermée par la feuille de capteur (20), bloquant la réoxygénation de la couche perméable à l'oxygène (21) de la feuille de capteur (20) de sorte que les micro-organismes (3) respirent directement dans la couche perméable à l'oxygène (21) de la feuille de capteur (20), dans lequel la couche perméable à l'oxygène (21) de la feuille de capteur (20) est dopée avec un colorant indicateur d'oxygène (26), chargée d'oxygène (4) et fait face à l'au moins une portion de la surface (2) ;

25

le placement (S2) d'un élément de détection (30) par rapport à la feuille de capteur (20) ;

l'excitation (S3) du colorant indicateur d'oxygène (26) dans la couche perméable à l'oxygène (21) avec une lumière d'excitation (32) à travers une couche de support de lecture au moins partiellement transparente imperméable à l'oxygène (24) de la feuille de capteur (20), la couche de support de lecture au moins partiellement transparente imperméable à l'oxygène (24) portant la couche perméable à l'oxygène (21) ; et

30

la détection (S4) d'une émission (27) du colorant indicateur d'oxygène (26) lorsque le colorant indicateur d'oxygène (26) est dans un état excité, l'émission (27) étant transmise à travers la couche de support de lecture au moins partiellement transparente imperméable à l'oxygène (24) de la feuille de capteur (20) par l'élément de détection (30) pendant ou après une période de temps (t), dans lequel l'émission (27) reçue du colorant indicateur d'oxygène (26) à partir de la couche perméable à l'oxygène (21) est indicative d'une diminution de l'oxygène (4) dans la couche perméable à l'oxygène (21) de la feuille de capteur (20) et donc d'une présence et d'une concentration des micro-organismes (3) sur l'au moins une portion de la surface (2) sous examen hermétiquement fermée par la feuille de capteur (20).

35

40

2. Procédé tel que revendiqué dans la revendication 1, dans lequel l'élément de détection (30) est une puce de détecteur (34) et la puce de détecteur (34) est directement attachée à la couche de support de lecture au moins partiellement transparente (24) pour recevoir l'émission (27) du colorant indicateur d'oxygène (26), ou la puce de détecteur (34) fait partie d'un dispositif de détection (38) et l'émission (27) du colorant indicateur d'oxygène (26) est imagée sur la puce de détecteur (34) pour détecter l'émission (27).

45

3. Procédé tel que revendiqué dans l'une quelconque des revendications précédentes, comprenant :

le post-traitement (S6) de l'émission (27) détectée, de sorte que la présence de micro-organismes (3) et leur distribution sont déterminées *in situ* par rapport à l'au moins une portion de la surface (2) ; et

l'affichage d'une représentation graphique ou d'une évaluation statistique (43, 47, 48, 50 à 58, 60 à 64) d'une concentration des micro-organismes (3) sur la surface (2) sur la base de l'émission (27) détectée ; dans lequel la représentation graphique ou l'évaluation statistique (43, 47, 48, 50 à 58, 60 à 64) de la concentration des micro-organismes (3) est une image bidimensionnelle de la distribution des micro-organismes (3) sur au moins une portion de la surface (2), un tracé, montrant le développement de la concentration des micro-organismes (3) dans le temps, ou une interprétation statistique des micro-organismes détectés.

55

4. Procédé tel que revendiqué dans l'une quelconque des revendications précédentes, dans lequel une réponse des micro-organismes (3) à l'au moins un colorant indicateur d'oxygène (26) ou à au moins un colorant indicateur d'oxygène (26) plus au moins un colorant de référence (28) dans la couche perméable à l'oxygène (21) de la feuille de capteur (20) est influencée.

5

5. Procédé tel que revendiqué dans la revendication 4, dans lequel

une température d'au moins une partie de la surface (2) sous examen est changée, par exemple par un chauffage relativement modéré, par exemple par infrarouge ou un système de tempéragé interne dans la feuille de capteur (20), afin de changer un degré d'activité des micro-organismes (3),

10

par exemple, les changements de température sont effectués par au moins une partie de la feuille de capteur (20) ; et/ou

au moins une partie de la surface (2) sous examen est traitée avec un rayonnement UV, de sorte que les micro-organismes (3) sont tués,

15

par exemple, le rayonnement UV est émis par au moins une partie de la feuille de capteur (20) ;

et/ou

au moins un découpleur respiratoire est placé sur la couche perméable à l'oxygène (21) de la feuille de capteur (20), de sorte que les micro-organismes (3) consomment plus d'oxygène (4) et qu'un temps de réponse plus rapide est obtenu,

20

par exemple, l'au moins un découpleur respiratoire est sélectionné spécifiquement pour certains micro-organismes (3), de sorte que des types spécifiques de micro-organismes (3) sont ciblés ; et/ou des antibiotiques spécifiques pour certains micro-organismes (3) sont sélectionnés de telle sorte que des types spécifiques de micro-organismes (3) sont sélectivement tués ou que des micro-organismes (3) résistants sont détectés.

25

6. Agencement (1) pour détecter des micro-organismes (3) sur une surface (2) sous examen,

l'agencement (1) étant **caractérisé par**

une feuille de capteur (20) ayant une couche perméable à l'oxygène (21) dopée avec un colorant indicateur d'oxygène (26) et chargée d'oxygène (4), et une couche de support de lecture au moins partiellement transparente imperméable à l'oxygène (24) portant la couche perméable à l'oxygène (21),

30

la feuille de capteur (20) ayant un premier et un second côté de surface libre opposés (22, 25), dans lequel le premier côté de surface libre (22) de la feuille de capteur (20) est un côté de surface libre de la couche perméable à l'oxygène (21), et le second côté de surface libre (25) de la feuille de capteur (20) est un côté de surface libre de la couche de support de lecture au moins partiellement transparente imperméable à l'oxygène (24),

35

le premier côté de surface libre (22) de la couche perméable à l'oxygène (21) de la feuille de capteur (20) étant attaché à au moins une portion de la surface (2) sous examen, et

l'au moins une portion de la surface (2) sous examen étant hermétiquement fermée par la feuille de capteur (20), bloquant la réoxygénation de la couche perméable à l'oxygène (21) de la feuille de capteur (20) de sorte que les micro-organismes (3) respirent directement dans la couche perméable à l'oxygène (21) de la feuille de capteur (20) ;

40

un élément de détection (30) agencé par rapport à la feuille de capteur (20) pour recevoir une émission (27) du colorant indicateur d'oxygène (26) lorsque le colorant indicateur d'oxygène (26) est dans un état excité, l'émission (27) étant transmise à travers la couche de lecture au moins partiellement transparente imperméable à l'oxygène (24) de la feuille de capteur (20) ;

45

une unité d'évaluation (40) pour calculer une représentation graphique ou statistique (43, 47, 48, 50 à 58, 60 à 64) de l'émission (27) reçue ; et

un afficheur (42) connecté à l'unité d'évaluation (40) et adapté pour afficher la représentation graphique ou statistique (43, 47, 48, 50 à 58, 60 à 64) de l'émission (27) reçue, la représentation graphique ou statistique (43, 47, 48, 50 à 58, 60 à 64) étant indicative d'une diminution de l'oxygène (4) dans la couche perméable à l'oxygène (21) de la feuille de capteur (20) et donc d'une présence et d'une concentration des micro-organismes (3) sur l'au moins une portion de la surface (2) sous examen hermétiquement fermée par la feuille de capteur (20).

50

7. Agencement tel que revendiqué dans la revendication 6, dans lequel une source de lumière (31), fournissant une lumière d'excitation (32), est placée par rapport à la feuille de capteur (20) de sorte qu'une lumière d'excitation (32) atteint la couche perméable à l'oxygène (21) qui est dopée avec le colorant indicateur d'oxygène (26) et chargée d'oxygène (4).

55

8. Agencement tel que revendiqué dans l'une quelconque des revendications 6 et 7, dans lequel l'élément de détection

(30) est une puce de capteur (34), et la puce de capteur (34) est directement attachée à la couche de support de lecture au moins partiellement transparente (24) pour recevoir l'émission (27) du colorant indicateur d'oxygène (26), et la puce de capteur (34) est en connexion de communication avec l'unité d'évaluation (40).

- 5 **9.** Agencement tel que revendiqué dans l'une quelconque des revendications 6 et 7, dans lequel l'élément de détection (30) est un dispositif de détection (38) comportant au moins une puce de détecteur (34) et une optique (35) maintenue en position par un boîtier (33), dans lequel l'optique (35) image l'émission (27) du colorant indicateur d'oxygène (26), transmise à travers la couche de lecture au moins partiellement transparente imperméable à l'oxygène (24) de la feuille de capteur (20), puis sur la puce de détecteur (34), et la puce de détecteur (34) est en connexion de communication avec l'unité d'évaluation (40), dans lequel le dispositif de détection (38) comprend au moins une source de lumière (31), adaptée pour diriger la lumière d'excitation (32) à travers la couche de support de lecture au moins partiellement transparente imperméable à l'oxygène (24) de la feuille de capteur (20) vers la couche perméable à l'oxygène (21) de la feuille de capteur (20), de sorte que le colorant indicateur d'oxygène (26) dans la couche perméable à l'oxygène (21) est excité par la lumière d'excitation (32) et émet l'émission (27).
- 10
- 15 **10.** Agencement (1) tel que revendiqué dans la revendication 9, dans lequel le dispositif de détection (30) est attaché de manière fixe ou détachable au second côté de surface libre (25) de la couche de support de lecture au moins partiellement transparente imperméable à l'oxygène (24) de la feuille de capteur (20).
- 20 **11.** Produit de programme informatique disposé sur un support non transitoire lisible par ordinateur pour détecter des micro-organismes (3) sur une surface (2) sous examen par l'agencement (1) tel que revendiqué dans l'une quelconque des revendications 6 à 10, le produit de programme informatique comprenant des étapes de traitement exécutables par ordinateur aptes à commander un ordinateur pour :
- 25
- lire des données à partir de l'au moins une puce de détecteur (34) qui est placée par rapport à la feuille de capteur (20) attachée de manière hermétiquement fermée à au moins une portion de la surface (2) à examiner et une couche de support de lecture au moins partiellement transparente imperméable à l'oxygène (24) de la feuille de capteur (20) fait face à la puce de détecteur (34) ;
 - calculer à partir des données lues une quantité des micro-organismes (3) et leur distribution sur au moins une portion de la surface (2) ; et
 - commander l'afficheur (42) pour montrer la représentation graphique ou statistique (43, 47, 48, 50 à 58, 60 à 64) d'une concentration des micro-organismes (3) sur la surface (2), sur la base de l'émission (27) détectée, dans ou après des intervalles de temps définis.
- 30
- 35 **12.** Produit de programme informatique tel que défini dans la revendication 11, dans lequel au moins une fenêtre d'image est définie sur la puce de détecteur (34) de sorte que les données sont seulement lues à partir de l'au moins une fenêtre d'image afin de calculer la quantité des micro-organismes (3).
- 40 **13.** Feuille de capteur (20) pour détecter des micro-organismes (3) sur une surface (2) sous examen, la feuille de capteur (20) comprenant :
- une couche perméable à l'oxygène (21) qui est dopée avec un colorant indicateur d'oxygène (26) et chargée d'oxygène (4), dans laquelle la couche perméable à l'oxygène (21) est adaptée pour être attachée de manière hermétiquement fermée à au moins une portion de la surface (2), bloquant la réoxygénation de la couche perméable à l'oxygène (21) ; et
 - une couche de support de lecture au moins partiellement transparente imperméable à l'oxygène (24), adaptée pour porter la couche perméable à l'oxygène (21), dans laquelle la feuille de capteur (20) est configurée de sorte que les micro-organismes (3) «respirent» directement dans la couche perméable à l'oxygène (21) de la feuille de capteur (20) et de sorte que la détection de micro-organismes (3) sur la surface (2) est basée sur une diminution de l'oxygène (4) dans la couche perméable à l'oxygène (21) de la feuille de capteur (20) lorsqu'elle est attachée de manière hermétiquement fermée à l'au moins une portion de la surface (2).
- 45
- 50
- 55 **14.** Feuille de capteur (20) telle que revendiquée dans la revendication 13, la feuille de capteur (20) étant pliable et flexible.
- 15.** Feuille de capteur (20) telle que revendiquée dans l'une quelconque des revendications 13 et 14, dans laquelle un premier côté de surface libre (22) de la couche perméable à l'oxygène (21) de la feuille de capteur (20) porte un motif régulier d'une pluralité de champs, dans laquelle chaque champ, sauf un, contient un type différent d'antibiotique.

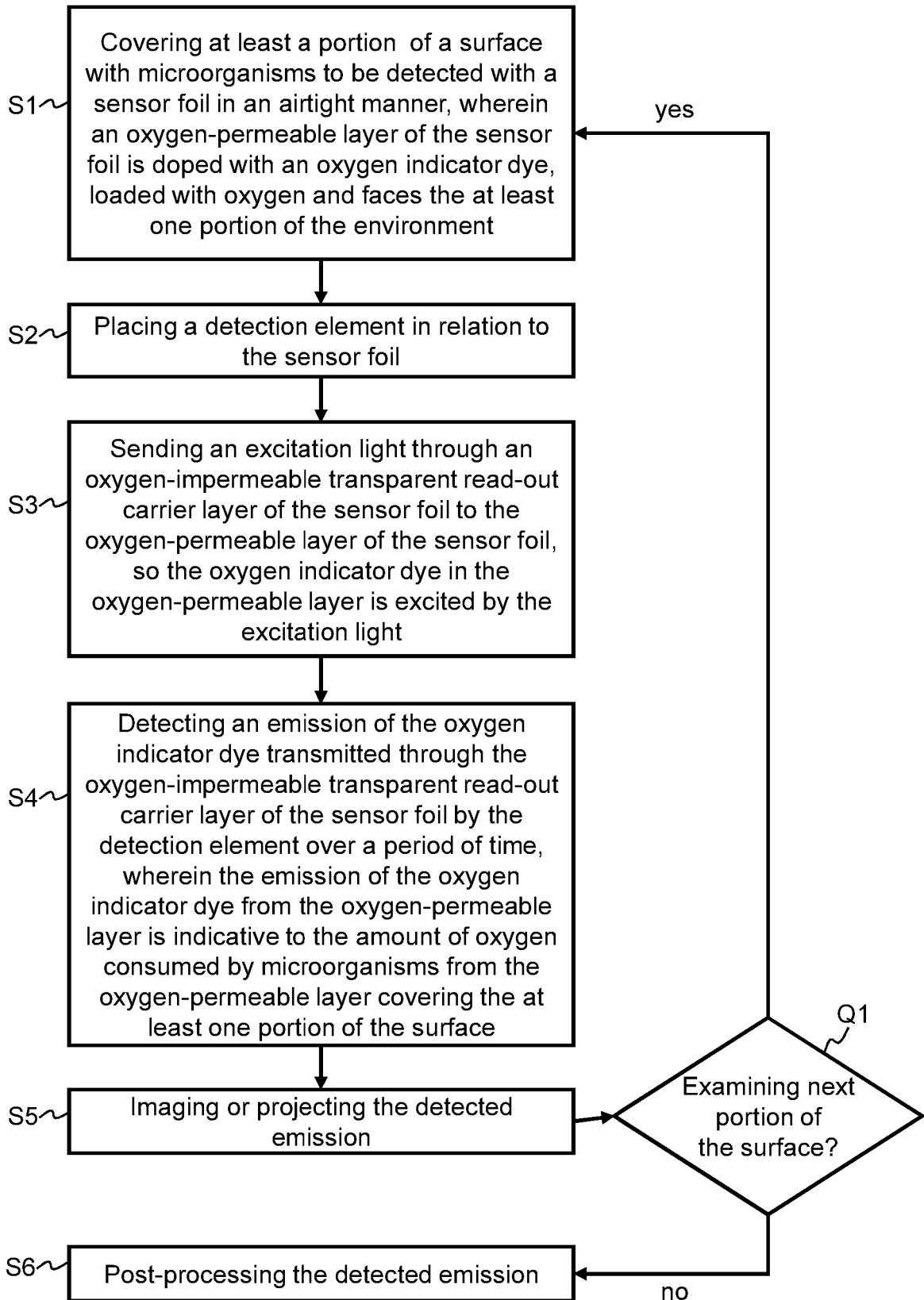

FIG. 1

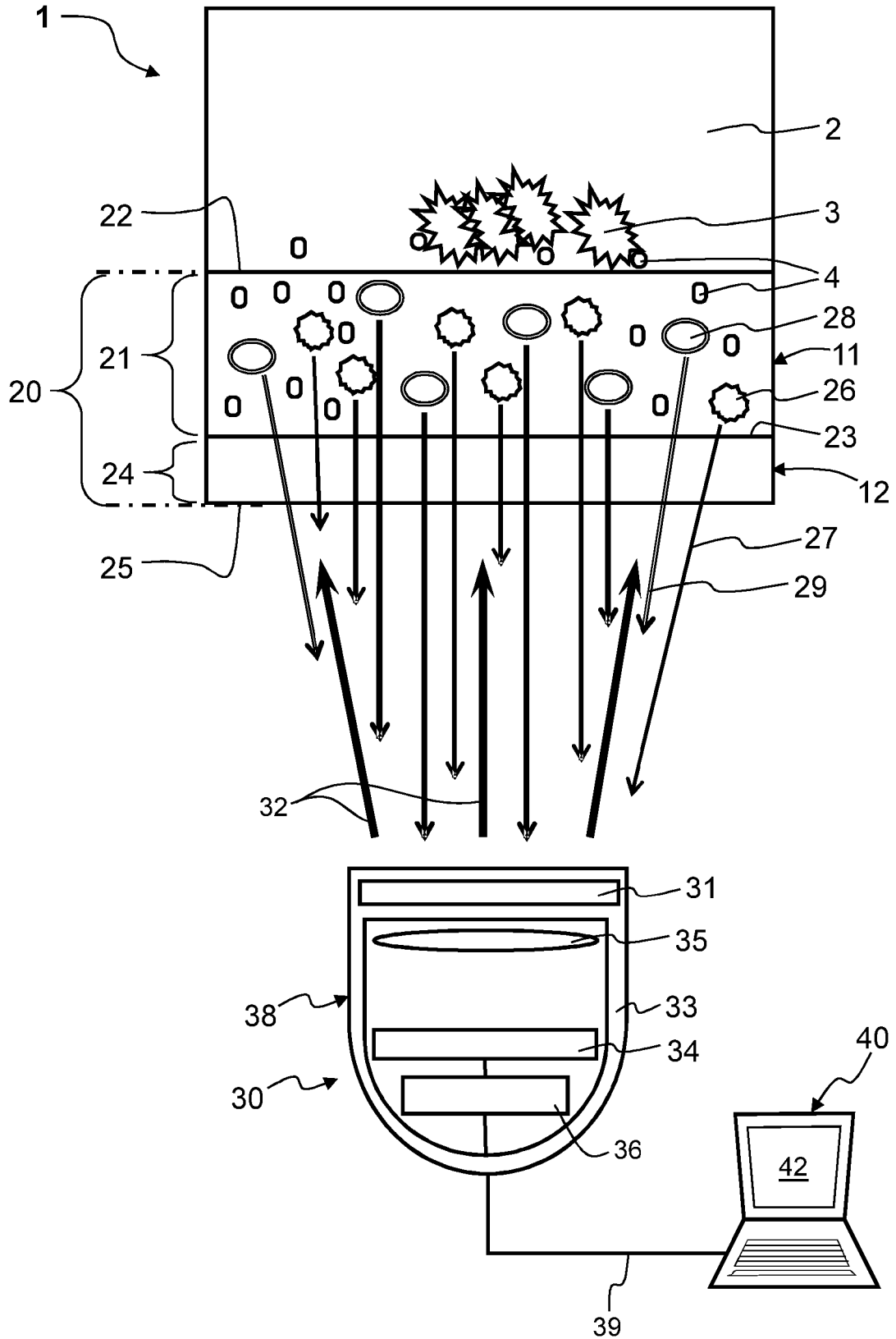

FIG. 2

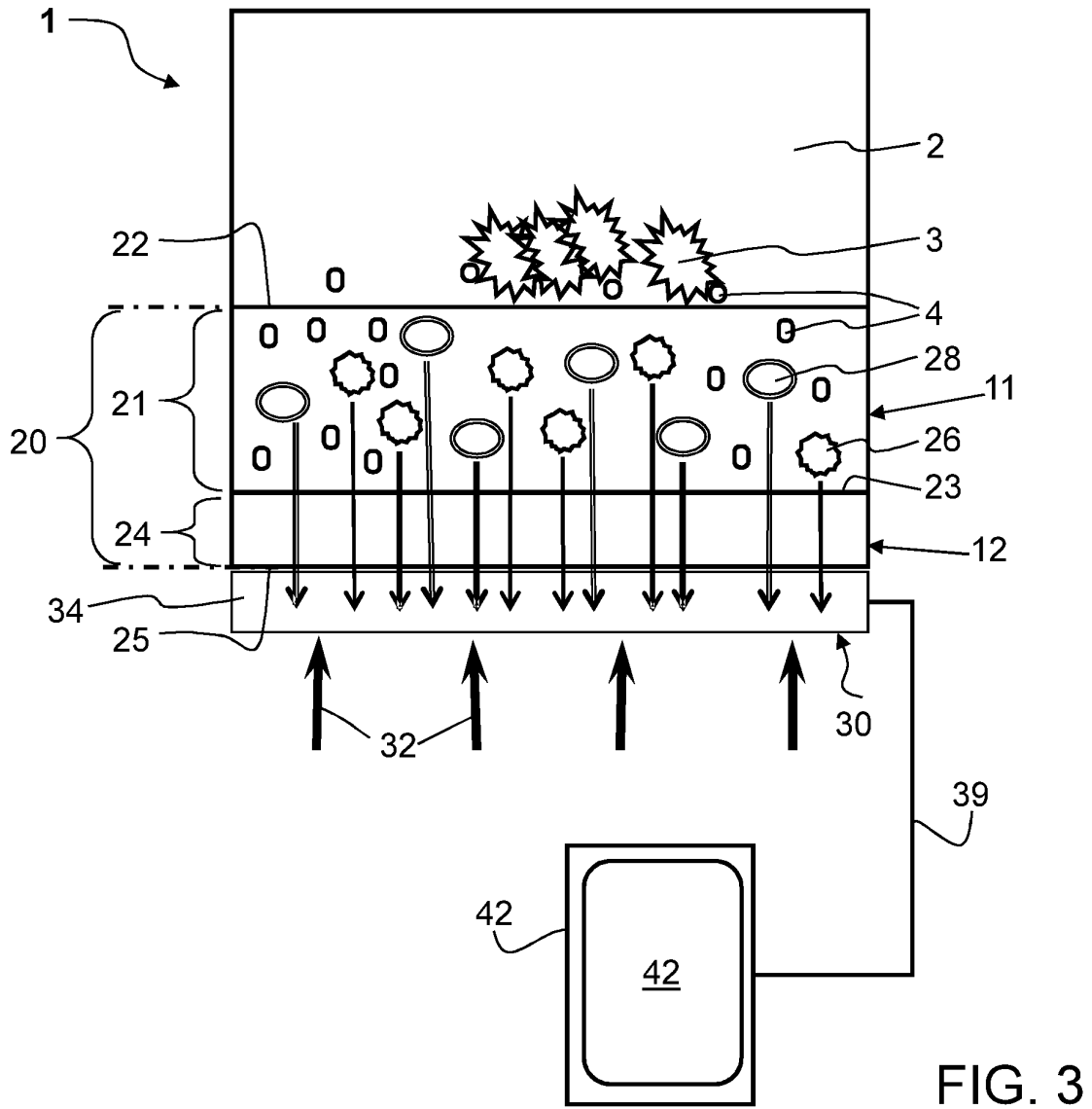

FIG. 3

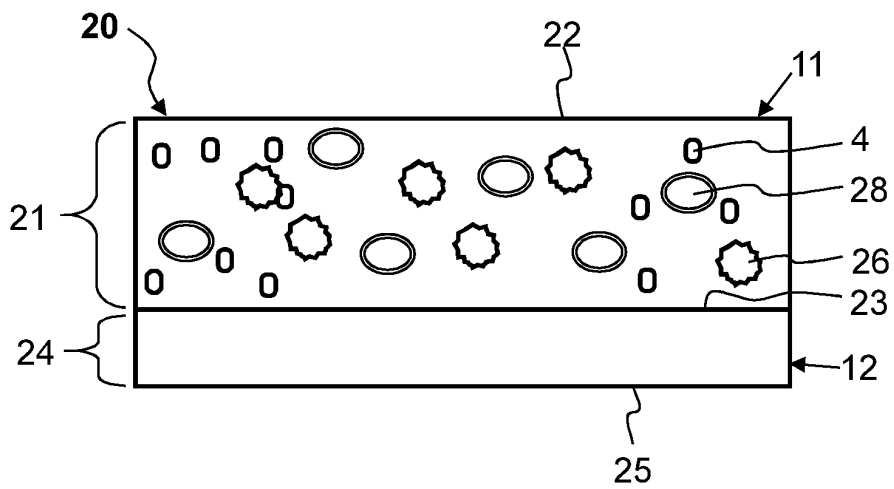
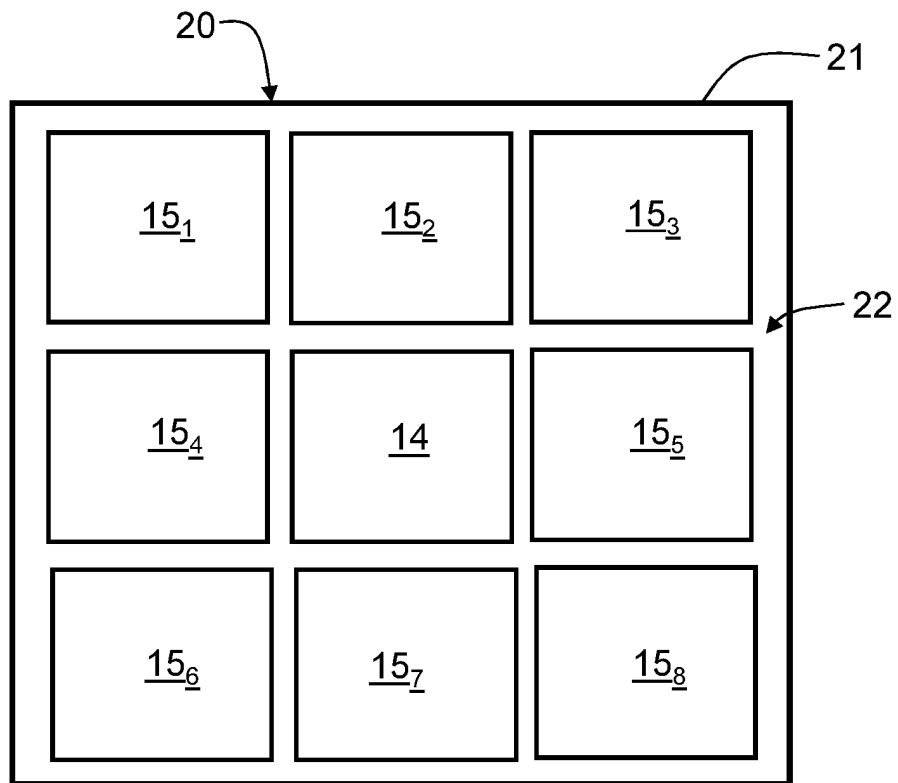
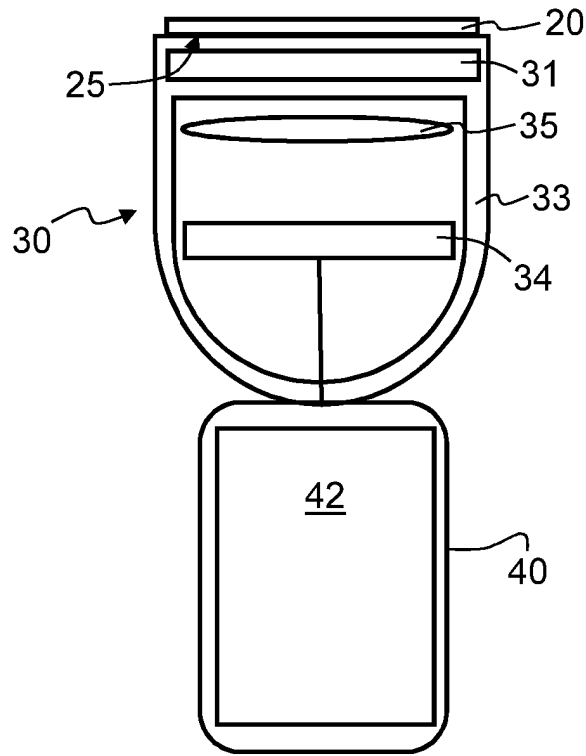

FIG. 4



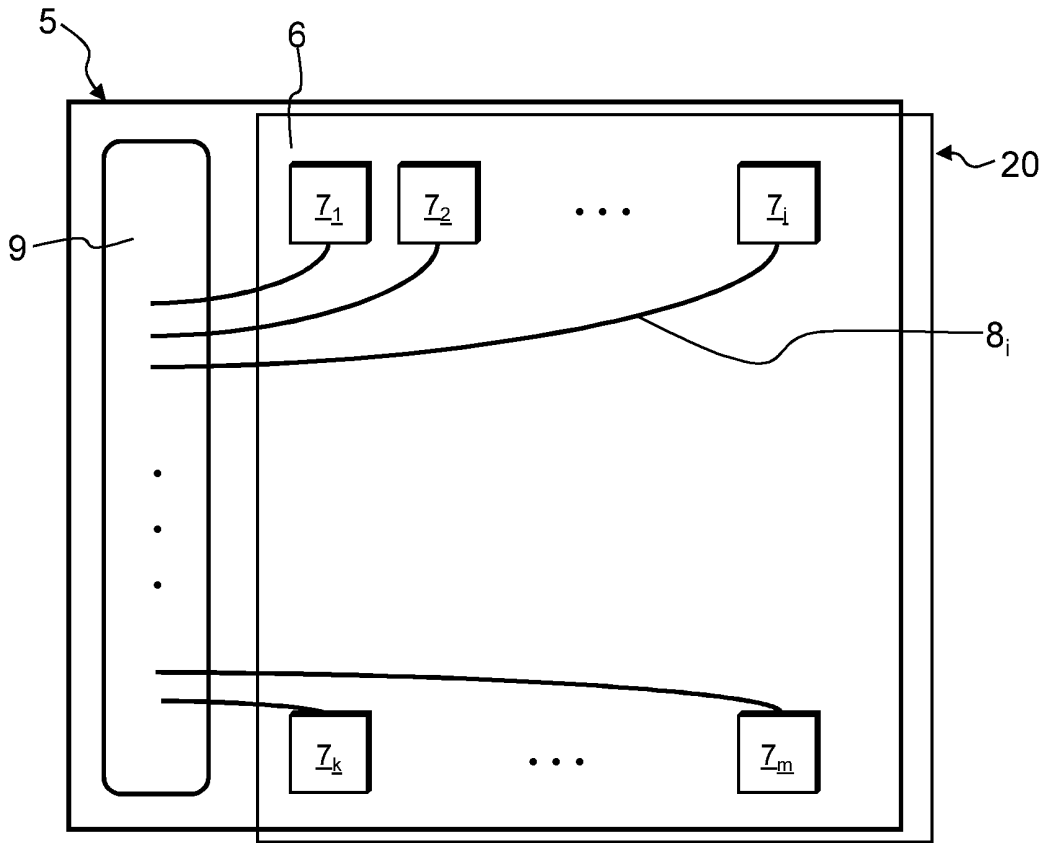

FIG. 7

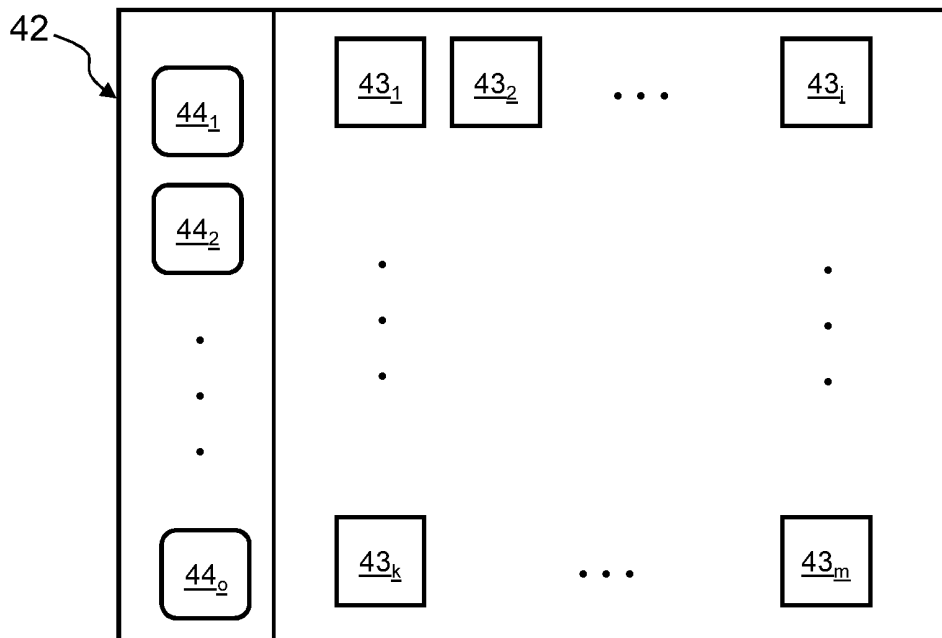

FIG. 8

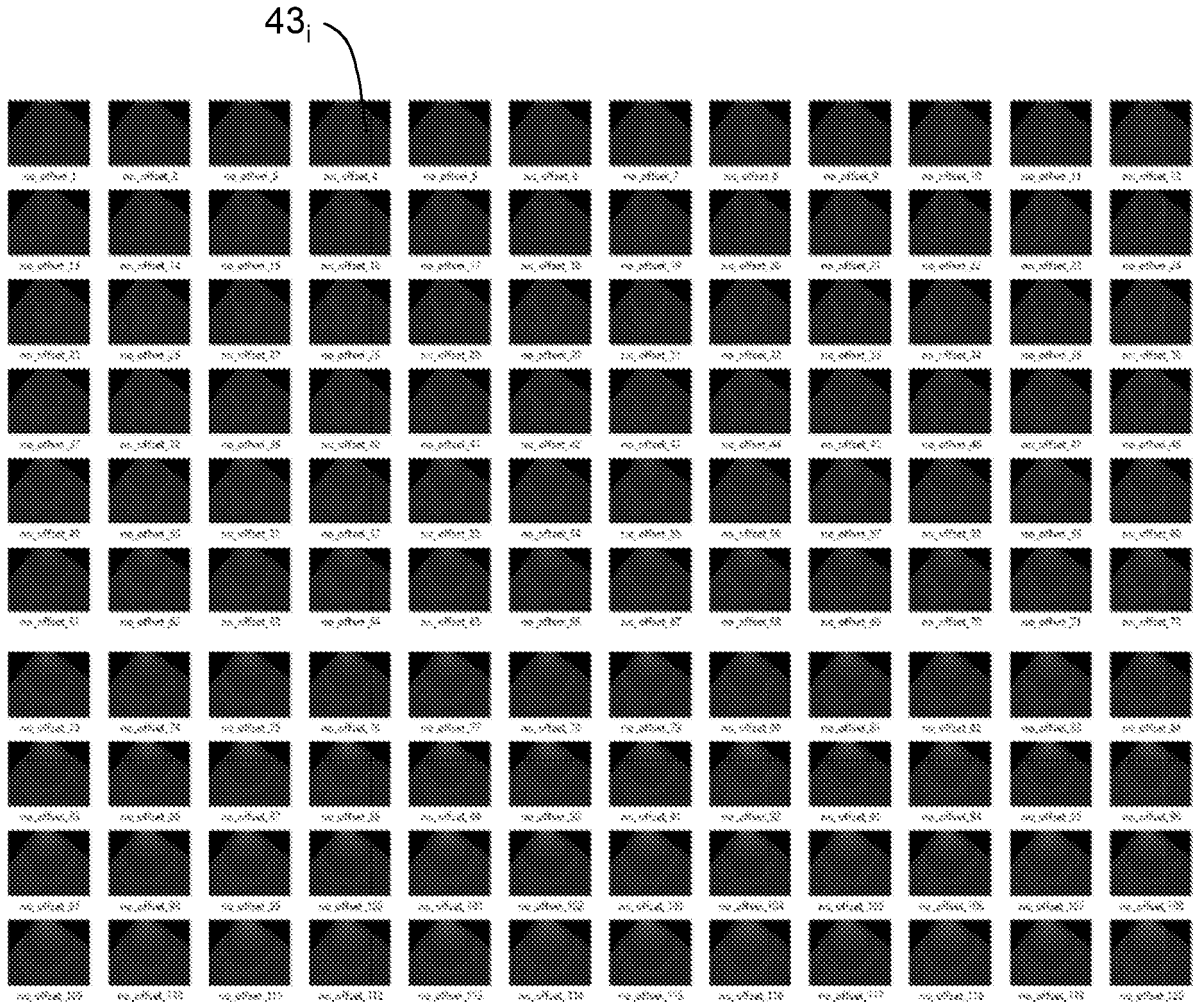

FIG. 9

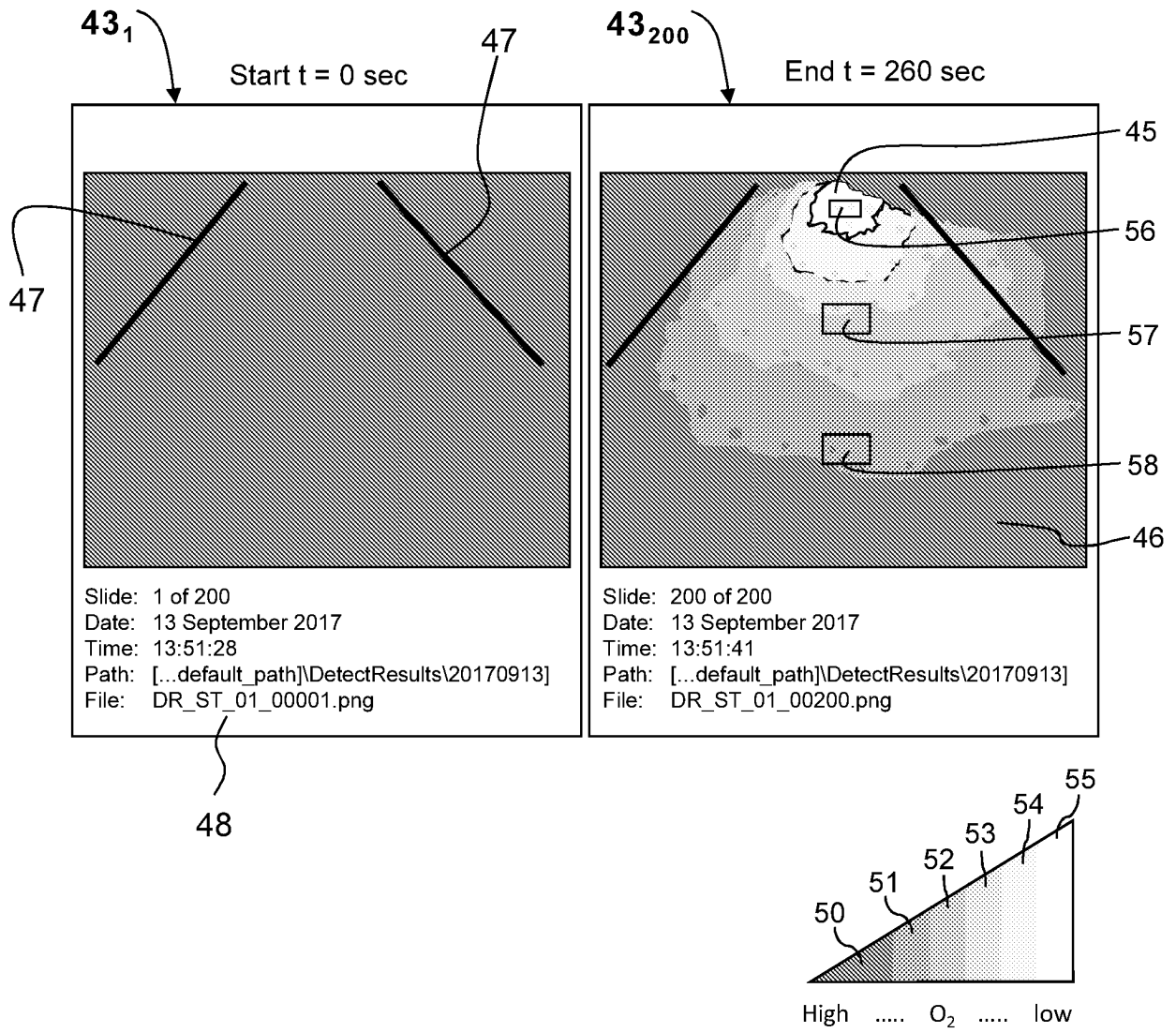
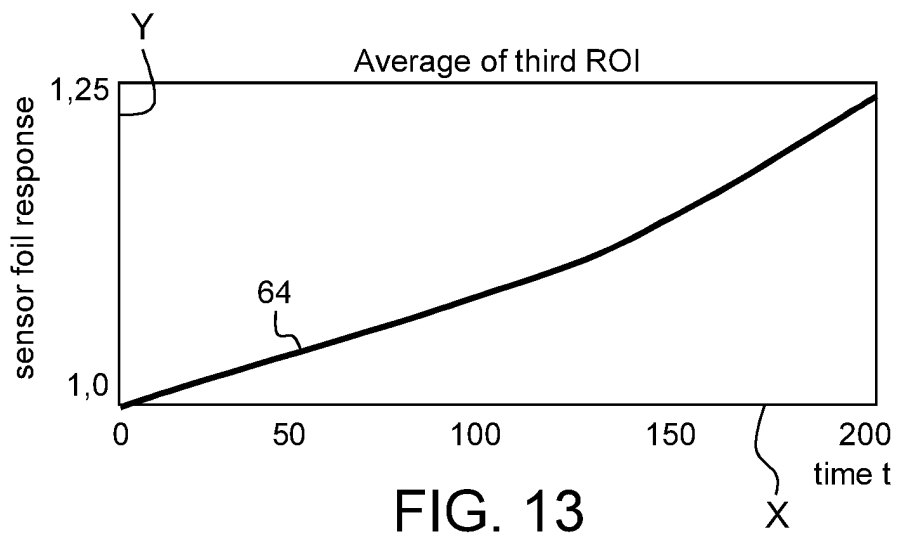
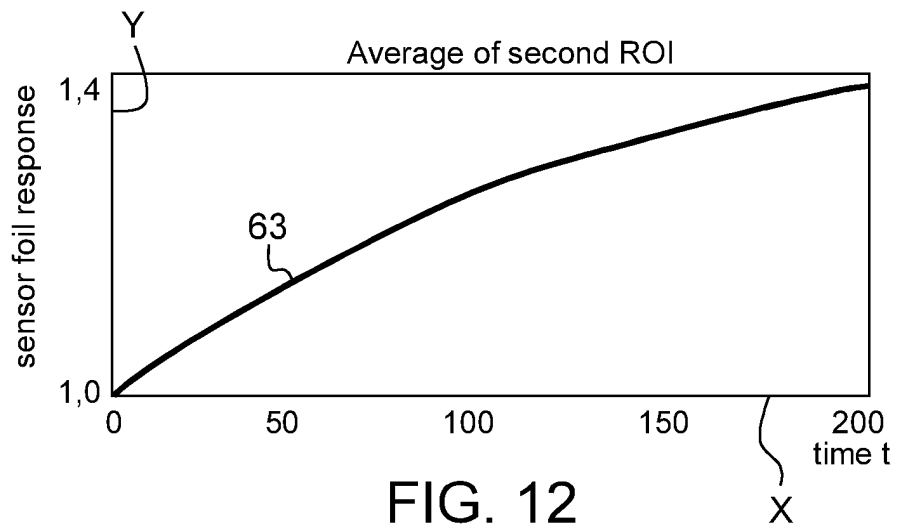
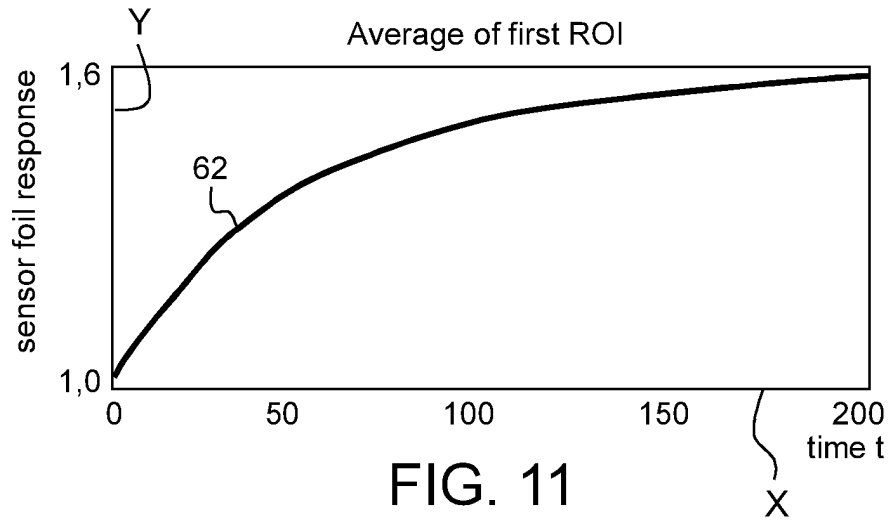

FIG. 10



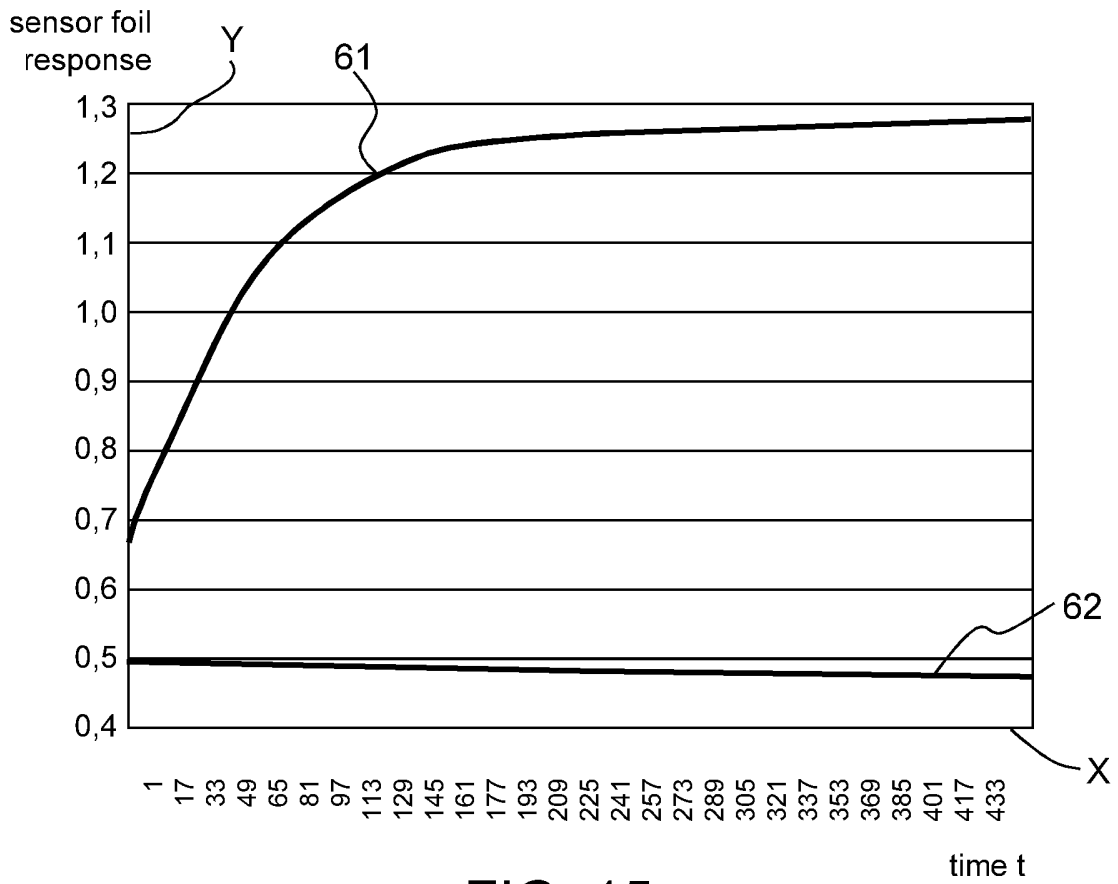
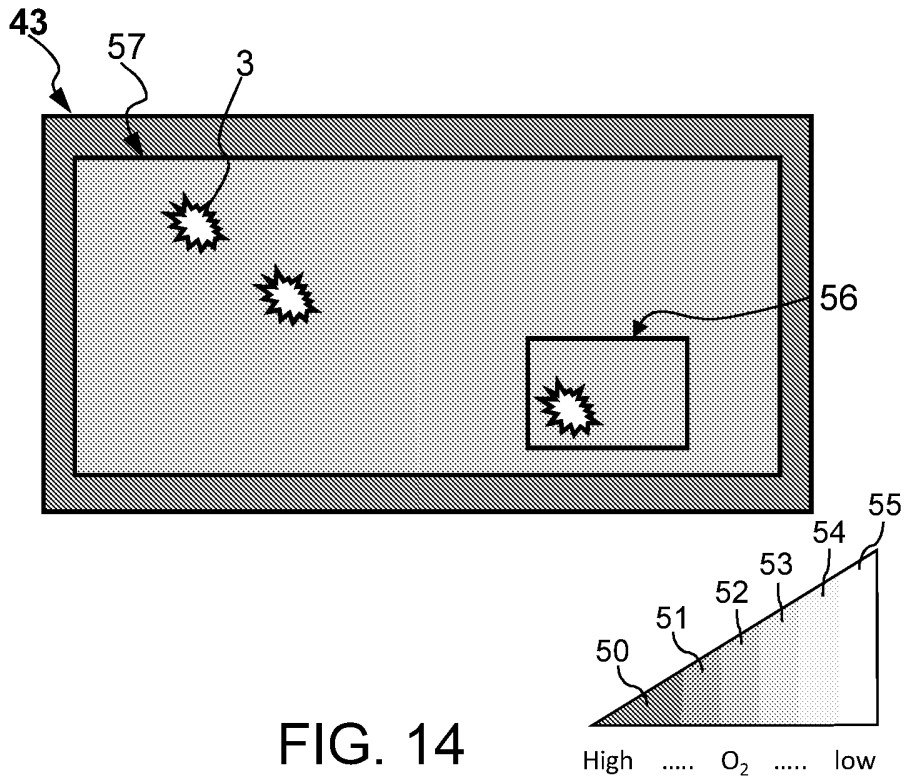

FIG. 15

REFERENCES CITED IN THE DESCRIPTION

This list of references cited by the applicant is for the reader's convenience only. It does not form part of the European patent document. Even though great care has been taken in compiling the references, errors or omissions cannot be excluded and the EPO disclaims all liability in this regard.

Patent documents cited in the description

- WO 2013122852 A1 [0008]
- US 2012145882 A1 [0009]
- US 4657736 A [0010]

Non-patent literature cited in the description

- **HENNING TSCHERSCH et al.** An imaging method for oxygen distribution, respiration and photosynthesis at a microscopic level of resolution. *New Phytologist*, November 2012, vol. 196 (3), ISSN 0028-646X, 926-936 [0007]
- **M KUHL et al.** Functional and structural imaging of phototrophic microbial communities and symbioses. *Aquatic Microbial Ecology*, 18 September 2008, vol. 53, ISSN 0948-3055, 99-118 [0008]